

**electroair**  
Direct Fire Ignition Systems

***EIS-41000***  
***Installation Manual***

***Electroair***  
***317 Catrell Dr, Suite #2***  
***Howell, MI 48843***  
***U.S.A.***  
***Ph: 517-552-9390 Fax: 517-552-9391***  
***Email: sales@electroair.net***

11/8/2012

Doc #: 1018-41000-6

REV 07

# **TABLE OF CONTENTS**

*EIS-41000 Installation Manual*

<b>Ignition System Technical Discussion</b>	<b>1.1</b>
Dual Magneto System	<b>1.1</b>
EIS Overview & Primer	<b>1.1</b>
<b>EIS / Direct Fire Ignition Technical Discussion</b>	<b>1.3</b>
How Direct Fire Ignition Works	<b>1.3</b>
High Resolution Single-Crankshaft-Sensor Decoding	<b>1.3</b>
Spark Plug Selection	<b>1.4</b>
Low Voltage Operation with Permanent Magnet-Type Starters	<b>1.5</b>
<b>EIS Kit Descriptions &amp; Requirements</b>	<b>2.1</b>
System Descriptions & Requirements	<b>2.1</b>
Other items you will need	<b>2.2</b>
<b>EIS Kit Contents &amp; Optional Parts</b>	<b>2.3</b>
Kit Contents	<b>2.3</b>
Optional Electroair Parts	<b>2.5</b>
<b>Overview of Four Cylinder Single Engine Aircraft EIS Installation</b>	<b>3.1</b>
<b>Installation of EIS-41000 and EIS-41000IC</b>	<b>3.2</b>
General Overview and Recommendations	<b>3.2</b>
Removal of Old Ignition Components	<b>3.3</b>
Set-up & Installation of p/n: EA-3000 MTH (EIS-41000 Kit Only)	<b>3.4</b>
Set-up & Installation of p/n: EA-3000IC Impulse Coupled MTH (EIS-41000IC Kit Only)	<b>3.5</b>
Installation of p/n: EA-1000 EIS Controller and p/n: EA-2000 Coil Pack	<b>3.8</b>
Installation of p/n: EA-5000 MAP Sensor	<b>3.11</b>
Installation of p/n: EA-4000 Spark Plug Harness	<b>3.12</b>
Connection of p/n: EA-6000 Wiring Harness	<b>3.14</b>
Final Installation Steps	<b>3.19</b>
Installation Options available from Electroair	<b>3.19</b>
<b>Overview of Four Cylinder Twin Engine Aircraft EIS Installation</b>	<b>4.1</b>
<b>Installation of EIS-41000T, EIS-41000TIC, EIS-41000TLH, &amp; EIS-41000TLHC</b>	<b>4.3</b>
General overview and recommendations	<b>4.3</b>
Removal of Old Ignition Components	<b>4.4</b>
Set-up & Installation of p/n: EA-3000 MTH (EIS-41000T Kit Only) and EA-3000LH MTH (EIS-41000TLH Kit Only)	<b>4.5</b>

Set-up & Installation of p/n: EA-3000IC MTH (EIS-41000TIC Kit Only) and EA-3000LHIC MTH (EIS-41000TLHIC Kit Only)	<b>4.7</b>
Installation of p/n: EA-1000 EIS Controllers and p/n: EA-2000 Coil Packs	<b>4.10</b>
Installation of p/n: EA-5000 MAP Sensors and Connection of Manifold Pressure Lines	<b>4.13</b>
Installation of p/n: EA-4000 Spark Plug Harnesses	<b>4.15</b>
Connection of p/n: EA-6000T Twin Engine Wiring Harnesses	<b>4.17</b>
Instrument Panel EIS Labeling	<b>4.22</b>
Final Installation Steps	<b>4.24</b>
Installation Options Available from Electroair	<b>4.24</b>
<b>Record of Revisions</b>	<b>5.1</b>

# ***Ignition System Technical Discussion***

## ***Dual Magneto System Review***

On a traditional dual magneto system, both magnetos are timed to fire at a preset degree before Top Dead Center (TDC). When starting the engine, the ignition switch grounds the 'P-lead' to the non-impulse coupled magneto, stopping it from firing. Meanwhile, the magneto with the impulse coupling can still fire. The impulse coupling causes the magneto to fire at TDC, and will continue to fire at TDC until the engine reaches about 200 RPM. At this time, the impulse coupling disengages and the magneto falls back to firing at the preset degree before TDC. Once the ignition switch is released from the start position, the non-impulse coupled magneto also begins to fire. From now on, no matter what the RPM, power setting, or altitude the engine spark timing will remain at the preset degree before TDC.

At any altitude, a cylinder on the intake stroke draws in fuel and air. At lower altitudes, on the compression stroke (as the piston moves up) at the preset degree before the piston reaches the top of the cylinder (TDC), the spark plug fires lighting the air/fuel mixture. The objective is to reach the peak pressure point (as a result of igniting the air/fuel mixture) by the time the piston reaches 11 to 17 degrees past TDC.

As altitude increases, thinner air reduces the oxygen available for the proper fuel-air mixture creating more space between the air/fuel molecules. When the spark plug fires at the preset degree before TDC, the thinner air/fuel mixture will burn slower. Therefore, the peak pressure point occurs much later than 17 degrees past TDC, and hence there is a loss in power. By advancing the timing based on RPM and atmospheric pressure, the peak pressure point can be maintained much closer to 11 to 17 degrees after TDC.

## ***EIS Overview & Primer***

Before discussing the detailed mechanics of how the EIS works, we should review the benefits and general operation of the EIS. The EIS differs from standard magneto systems in one very significant way: **TIMING**. In a magneto, timing is permanently set; the EIS adjusts timing (or spark advance) based on RPM and manifold pressure. This ability to adjust the spark advance allows the EIS to determine the optimum timing setting which produces the most power with the least fuel.

$$\text{EIS Spark Advance (Timing)} = \text{Mechanical Advance} \\ + \text{RPM Advance} + \text{Vacuum Advance}$$

The mechanical advance is set during the installation of the EIS timing housing or crankshaft sensor. This setting is usually zero degrees of TDC.

The final component for the total amount of timing comes from the vacuum advance, or Manifold Pressure Sensor. The manifold pressure is sensed and calculated in to the total spark advance. These two measurements are used together to determine the most efficient timing setting for the engine. The MAP Sensor will add a maximum of 15" of advance to the total Spark Advance. Refer to the following Vacuum Advance Curve Chart, fig. 1:

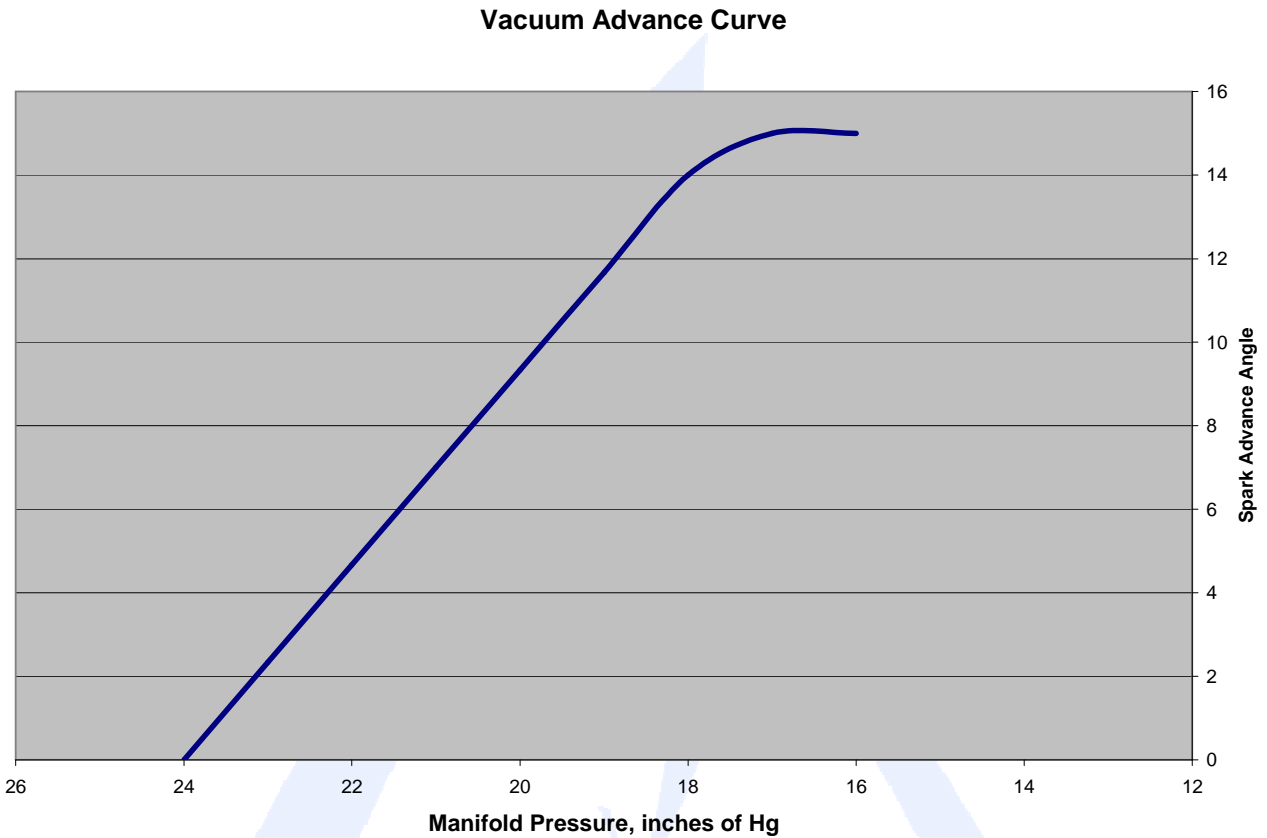

Figure 1

If the MAP Sensor (manifold absolute pressure or vacuum) option is not installed, then the vacuum advance value in the above equation would be zero. Without the MAP sensor installed, the advance remains zero up to the 250 RPM. At 250 RPM, it advances to 7 degrees BTDC, and then at 400 RPM, the unit advances to the spark advance setting for your engine (this is set at the factory) and will remain at that setting for operation.

## ***EIS/Direct Fire Ignition Technical Discussion***

### **How Direct Fire Ignition Works**

A "Direct Fire" ignition fires the spark plugs directly from the coils and not through a distributor cap and rotor. This is accomplished by using multiple coils, each with two spark terminals. The coil terminals are connected to the spark plugs, allowing one cylinder to fire on compression while its companion cylinder fires simultaneously on exhaust. Open spark gaps in the rotor and cap are eliminated, making wear and moisture problems a thing of the past.

What sets the Electroair Ignition System (EIS) apart is the ability to charge multiple ignition coils at the same time. This increased dwell time means that full spark energy is available over the entire RPM range (up to 9600 RPM at 12 volts). Unlike capacitive discharge systems that only put out one very short spark, the EIS puts out a full energy, long burning spark at your highest and most critical engine speeds. Long burn times assure effective burning of even lean fuel mixtures.

The brain of the EIS includes dual digital microprocessors using patented spark algorithms, which takes the electrical signal from the crankshaft (or mag timing housing) sensor, identifies top-dead center and then keeps track of the remaining rotation. The EIS determines engine speed and computes the spark advance using the settings pre-set at the factory for your engine as a base-line. Settings from the factory are preset for the engine's certified placarded timing. Additionally, the EIS receives engine manifold pressure information and advances the ignition to compensate for altitude and throttle position.

Beyond the synchronization and firing the plugs at the correct advance angle, the EIS also computes the exact dwell time to produce 9 amps of coil current. Coil charging is dynamically measured, so changes in RPM, battery voltage, or temperature are accounted for on every spark. This corrects any errors that are caused by battery voltage or coil temperature changes and insures maximum spark energy.

### **High Resolution Single-Crankshaft-Sensor Decoding**

The EIS uses a single, high resolution, 60-minus-2 tooth crank trigger wheel. This affords resolution unheard of in any other electronic ignition available today, offering spark accuracy of  $\frac{1}{4}$  degree of crankshaft rotation. This accuracy means the system is ideal for the most demanding engine applications – *that's why it has set altitude and speed records.*

In summary, your Electroair EIS delivers more power because:

- Spark timing is precisely controlled under all conditions, including rapid engine acceleration.
- Longer dwell time and a better flame front allow the engine to run better on lean and lean of peak mixture settings.
- Accurate spark timing allows sustained engine operation closer to peak power timing.
- 100% spark energy up to 9600 RPM on 6 cylinder and 12,000 RPM on 4 cylinder applications (at 12 volts).
- Long spark duration (typical durations of approximately 25 degrees)!

- Built-in timing computer
- No power draining magnetos to drive
- No moving parts to wear out or replace

## Spark Plug Selection

As was previously stated, spark plugs are generally more important to spark quality than spark plug wires. Most spark plugs exhibit failure when exposed to a large load. Failure usually consists of either intermittent sparking or arc-over. Arc-over is when the spark occurs between the spark plug wire and the engine block, instead of at the plug tip. Arc over is exacerbated by the use of low-quality wires, or wires that have cuts in the insulation.

The load at which a spark plug fails is different for all spark plugs. With the EIS's charging circuit, the more load you put on an engine, the more voltage will be applied to the plug. This is a beneficial situation: for a high compression engine, the voltage at the plug will be inherently higher (since there is more load). The detriment is that spark plugs and wires are only rated to a certain voltage (30-40,000 volts is typical), and can begin to "blow out" at around 40,000 volts. If that voltage is exceeded by a large amount for a long enough length of time, the spark plugs will either blow out, break down or arc to somewhere other than the electrode (often through the insulator directly to the engine block).

Your installation manual specifies the recommended gap for your engine application. This gap will be larger than a typical aircraft plug gap because of the higher energy output from the EIS. This is perfectly acceptable with our ignition charging method, since the high load of the cylinder pressure will allow the voltage to be quite high at the electrode; the gap will keep the plug from seeing an over-voltage situation.

The bottom line is this: the EIS system uses an *inductive* (long duration charge at battery voltage) charging method for the coils, which is completely different than the *capacitive* (short duration charge at higher-than-battery voltage) charging method used by other manufacturers. What may work well for these systems may not work well for ours. Our experience has drawn us to the following guidelines for spark plug application:

- All aircraft spark plugs will work with the EIS. We have found that the REM37BY (or equivalent) plugs work the best because they are easier to gap to the range required and fit the broadest heat range recommended by the engine manufacturer. We strongly recommend that you verify the heat range for your engine and use the appropriate plug.
- Electroair manufactures two aviation spark plugs that are gapped at the factory to Electroair's recommended wide gap range. Electroair manufactures an REM37BY equivalent plug; the Electroair part number for this plug is EAREM37HE. Electroair manufactures an RHM38S equivalent plug; the Electroair part number for this plug is EARHM38SE. Both Electroair spark plugs, p/n EAREM37HE & EARHM38SE, have been FAA approved for use with Electroair's certified EIS-41000 ignition systems. These plugs are only approved for use with Electroair's EIS.

## Low Voltage Operation with Permanent Magnet-Type Starters

There has been much discussion regarding the newer style, lightweight starters that use permanent magnets as the basis of their technology. To understand some of the issues, we must first understand one basic design characteristic of a permanent magnet lightweight starter: it needs a lot of power to get started! Since most permanent magnetic starters are derivatives of small automobile engine starters, their motors are first found in automobile chassis where batteries are substantially larger than typical light aircraft batteries and hence, have more available power. When these designs were adapted to aircraft, they failed to take into account the smaller batteries typically associated with light aircraft (25 amp-hour batteries and smaller). Permanent magnet starters typically draw between 30%-40% more energy than their larger, older style counterparts that they typically replace. This has left the entire aircraft electrical system, including the electronic ignition system, competing with the starter at the beginning of the flight cycle for power.

Most electronic ignition systems, Electroair's included, require a minimum amount of power available in order to operate correctly. In the case of the Electroair EIS, the minimum system voltage required is 8V. If the system voltage falls below that value for any length of time, the EIS will not function properly and can potentially cause the engine to 'kick-back'. This event can happen during the start-up of an aircraft engine using a permanent magnet starter if, for instance, the battery is not a peak charge. It is strongly recommended that an operator of one of these starters with an EIS always keep a full charge on their battery. Other suggestions that have come from some starter manufacturers include adding a dual battery to support the starting requirements. Electroair also supports the idea of a dual battery system, in particular, for potential emergency situations. This solution, however, has to be balanced with what the original weight considerations of the aircraft were in the first place.

One other alternative which has the benefits of a lightweight starter and does not have the draw backs of permanent magnet type starter is to use a series wound starter. A series wound starter uses a series wound motor as the drive unit and draws much less power than a permanent magnet starter and is less susceptible to problems inherent to permanent magnet starters – like hot starts. A hot engine reduces the effectiveness of a permanent magnet starter.

Another remaining solution to the low voltage problem associated with permanent magnet starters is to remain with the old style, Prestolite or Delco starter. These are heavier, obviously, than their counterparts, but there have not been significant problems reported about their operation with an electronic ignition system.

Please contact Electroair technical support if you are experiencing any starting problems. There are several solutions available.



## ***EIS-41000 Kit Descriptions & Requirements***

### ***EIS-41000 System Description & Requirements:***

1. This EIS Kit replaces one NON-impulse coupled magneto on the engine of a single engine aircraft
2. 12V or 24V electrical system
3. Manifold pressure line for installing the MAP sensor
4. A Direct Drive Magneto gear (NOT PROVIDED IN EIS KIT)
5. Toggle Switch x 1 (NOT PROVIDED IN EIS KIT)
6. 2 amp circuit breaker or fuse x 1 (NOT PROVIDED IN EIS KIT)
7. 10 amp circuit breaker or fuse x 1 (NOT PROVIDED IN EIS KIT)

### ***EIS-41000IC System Description & Requirements:***

1. This EIS Kit replaces one impulse coupled magneto on the engine of a single engine aircraft
2. 12V or 24V electrical system
3. Manifold pressure line for installing the MAP sensor
4. A Magneto Impulse Coupler and Drive Gear (NOT PROVIDED IN EIS KIT)
5. Toggle Switch x 1 (NOT PROVIDED IN EIS KIT)
6. 2 amp circuit breaker or fuse x 1 (NOT PROVIDED IN EIS KIT)
7. 10 amp circuit breaker or fuse x 1 (NOT PROVIDED IN EIS KIT)

### ***EIS-41000T System Description & Requirements:***

1. This EIS Kit replaces one NON-impulse coupled magneto on ONE standard-rotating engine of a twin engine aircraft
2. 12V or 24V electrical system
3. Manifold pressure line for installing the MAP sensor
4. A Direct Drive Magneto gear (NOT PROVIDED IN EIS KIT)
5. 2 amp circuit breaker or fuse x 1 (NOT PROVIDED IN EIS KIT)
6. 10 amp circuit breaker or fuse x 1 (NOT PROVIDED IN EIS KIT)

### ***EIS-41000TLH System Description & Requirements:***

1. This EIS Kit replaces one NON-impulse coupled magneto on the counter-rotating engine of a twin engine aircraft
2. 12V or 24V electrical system
3. Manifold pressure line for installing the MAP sensor
4. A Direct Drive Magneto gear (NOT PROVIDED IN EIS KIT)
5. 2 amp circuit breaker or fuse x 1 (NOT PROVIDED IN EIS KIT)
6. 10 amp circuit breaker or fuse x 1 (NOT PROVIDED IN EIS KIT)

### ***EIS-41000TIC System Description & Requirements:***

1. This EIS Kit replaces one impulse coupled magneto on ONE standard-rotating engine of a twin engine aircraft
2. 12V or 24V electrical system
3. Manifold pressure line for installing the MAP sensor
4. A Magneto Impulse Coupler and Drive Gear (NOT PROVIDED IN EIS KIT)
5. 2 amp circuit breaker or fuse x 1 (NOT PROVIDED IN EIS KIT)
6. 10 amp circuit breaker or fuse x 1 (NOT PROVIDED IN EIS KIT)

***EIS-41000TLHIC System Description & Requirements:***

1. This EIS Kit replaces one impulse coupled magneto on the counter-rotating engine of a twin engine aircraft
2. 12V or 24V electrical system
3. Manifold pressure line for installing the MAP sensor
4. A Magneto Impulse Coupler and Drive Gear (NOT PROVIDED IN EIS KIT)
5. 2 amp circuit breaker or fuse x 1 (NOT PROVIDED IN EIS KIT)
6. 10 amp circuit breaker or fuse x 1 (NOT PROVIDED IN EIS KIT)

***Other items you will need:***

1. If you are replacing a Bendix Magneto, you will need the Slick-type MAG holders to mount the EA-3000, EA-3000IC, EA-3000LH, or EA-3000LHIC. They are available directly from Electroair as p/n EA-015.
2. Basic tools and standard aircraft hardware required for mounting EIS controller, coil pack, and MAP sensor.
3. Electrical tools for cutting, stripping and terminating various wiring. Also recommended is a good selection of cable ties for harness routing and tie-off

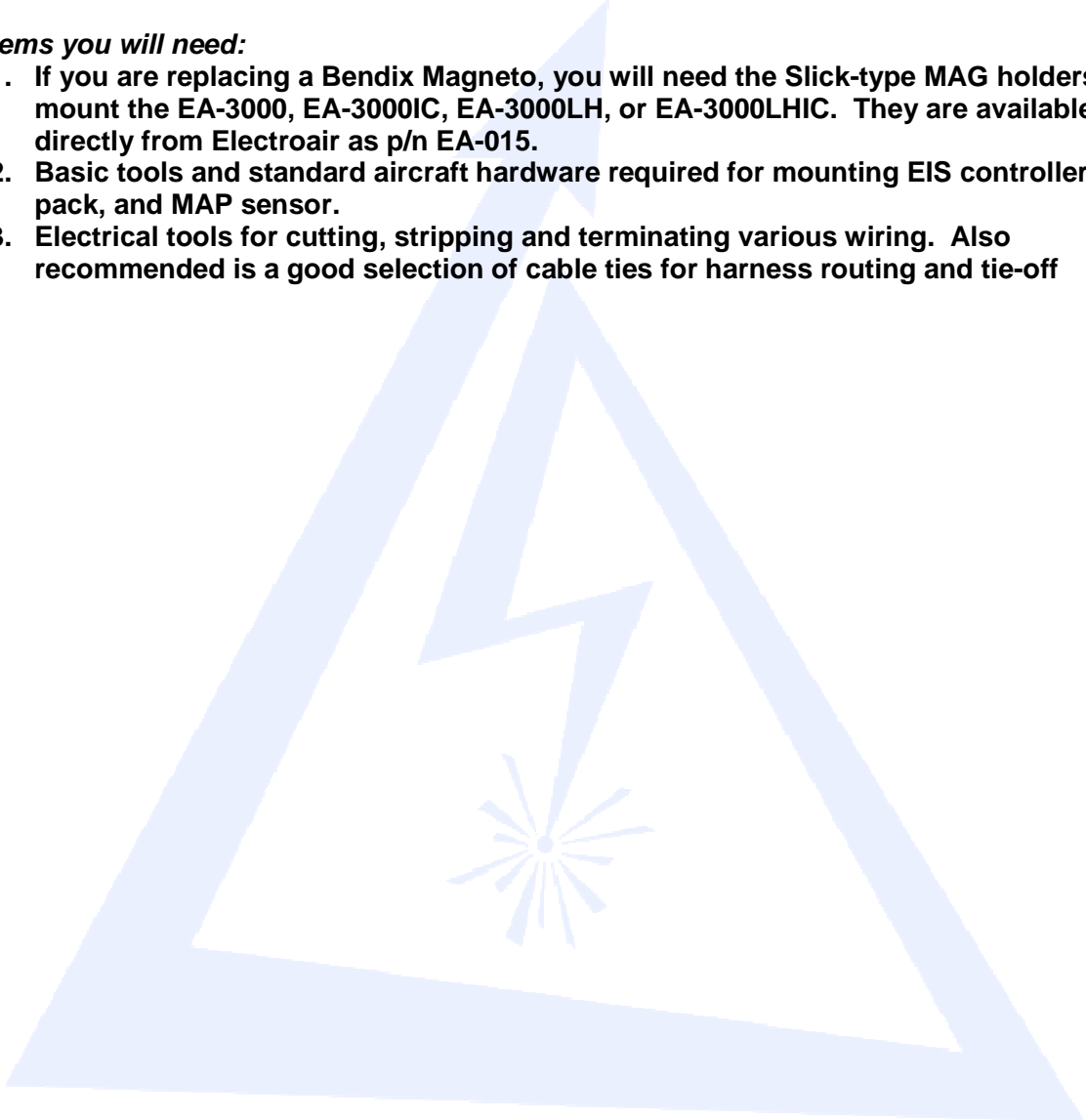

## ***EIS-41000 Kit Contents & Optional Parts***

### ***EIS-41000 Kit Contents:***

1. \_\_\_ EIS Controller (EA-1000)
2. \_\_\_ Coil Pack (EA-2000)
3. \_\_\_ EA-2000 Coil Plate Hardware Kit
4. \_\_\_ MAG Timing Housing (EA-3000)
5. \_\_\_ EA-3000 MTH Hardware Kit
6. \_\_\_ MAP Sensor (EA-5000)
7. \_\_\_ Spark Plug Wires (EA-4000) x 2 Bundles
8. \_\_\_ EA-4000 REM Hardware Kit
9. \_\_\_ Wiring Harness (EA-6000)
10. \_\_\_ ZIP Drive Containing System Documents (Installation Manual)

### ***EIS-41000IC Kit Contents:***

1. \_\_\_ EIS Controller (EA-1000)
2. \_\_\_ Coil Pack (EA-2000)
3. \_\_\_ EA-2000 Coil Plate Hardware
4. \_\_\_ Impulse Coupled MAG Timing Housing (EA-3000IC)
5. \_\_\_ EA-3000IC MTH Hardware Kit
6. \_\_\_ MAP Sensor (EA-5000)
7. \_\_\_ Spark Plug Wires (EA-4000) x 2 Bundles
8. \_\_\_ EA-4000 REM Hardware Kit
9. \_\_\_ Wiring Harness (EA-6000)
10. \_\_\_ ZIP Drive Containing System Documents (Installation Manual)

### ***EIS-41000T Kit Contents:***

1. \_\_\_ EIS Controller (EA-1000)
2. \_\_\_ Coil Pack (EA-2000)
3. \_\_\_ EA-2000 Coil Plate Hardware Kit
4. \_\_\_ MAG Timing Housing (EA-3000)
5. \_\_\_ EA-3000 MTH Hardware Kit
6. \_\_\_ MAP Sensor (EA-5000)
7. \_\_\_ Spark Plug Wires (EA-4000T) x 2 Bundles
8. \_\_\_ EA-4000 REM Hardware Kit
9. \_\_\_ Twin Engine Wiring Harness (EA-6000T)
10. \_\_\_ Instrument Panel Label Kit
11. \_\_\_ ZIP Drive Containing System Documents (Installation Manual)

***EIS-41000TLH Kit Contents:***

1. \_\_\_ EIS Controller (EA-1000)
2. \_\_\_ Coil Pack (EA-2000)
3. \_\_\_ EA-2000 Coil Plate Hardware Kit
4. \_\_\_ Counter-Rotating MAG Timing Housing (EA-3000LH)
5. \_\_\_ EA-3000 MTH Hardware Kit
6. \_\_\_ MAP Sensor (EA-5000)
7. \_\_\_ Spark Plug Wires (EA-4000T) x 2 Bundles
8. \_\_\_ EA-4000 REM Hardware Kit
9. \_\_\_ Twin Engine Wiring Harness (EA-6000T)
10. \_\_\_ Instrument Panel Label Kit
11. \_\_\_ ZIP Drive Containing System Documents (Installation Manual)

***EIS-41000TIC Kit Contents:***

1. \_\_\_ EIS Controller (EA-1000)
2. \_\_\_ Coil Pack (EA-2000)
3. \_\_\_ EA-2000 Coil Plate Hardware Kit
4. \_\_\_ Impulse Coupled MAG Timing Housing (EA-3000IC)
5. \_\_\_ EA-3000IC MTH Hardware Kit
6. \_\_\_ MAP Sensor (EA-5000)
7. \_\_\_ Spark Plug Wires (EA-4000T) x 2 Bundles
8. \_\_\_ EA-4000 REM Hardware Kit
9. \_\_\_ Twin Engine Wiring Harness (EA-6000T)
10. \_\_\_ Instrument Panel Label Kit
11. \_\_\_ ZIP Drive Containing System Documents (Installation Manual)

***EIS-41000TLHIC Kit Contents:***

1. \_\_\_ EIS Controller (EA-1000)
2. \_\_\_ Coil Pack (EA-2000)
3. \_\_\_ EA-2000 Coil Plate Hardware Kit
4. \_\_\_ Counter-Rotating Impulse Coupled MAG Timing Housing (EA-3000LHIC)
5. \_\_\_ EA-3000IC MTH Hardware Kit
6. \_\_\_ MAP Sensor (EA-5000)
7. \_\_\_ Spark Plug Wires (EA-4000T) x 2 Bundles
8. \_\_\_ EA-4000 REM Hardware Kit
9. \_\_\_ Twin Engine Wiring Harness (EA-6000T)
10. \_\_\_ Instrument Panel Label Kit
11. \_\_\_ ZIP Drive Containing System Documents (Installation Manual)

**Optional Electroair Parts:**

1. **P/N: EAREM37HE. Electroair's Massive Electrode Spark Plug.** This plug is Electroair's version of the standard REM37BY spark plug manufactured with a 0.036" air gap and has been approved for use with only Electroair's electronic ignition systems. These plugs come with the increased air gap Electroair recommends be used with our systems and eliminates the time and headache of re-gapping standard aircraft spark plugs. These Electroair spark plugs are not included in the standard EIS Kit. Please contact Electroair or one of our distributors for current pricing and availability of this spark plug.
2. **P/N: EARHM38SE. Electroair's Single Fine Wire Spark Plug.** This plug is Electroair's version of the standard RHM38S spark plug manufactured with a 0.036" air gap and has been approved for use with only Electroair's electronic ignition systems. These plugs come with the increased air gap Electroair recommends be used with our systems and eliminates the time and headache of re-gapping standard aircraft spark plugs. These Electroair spark plugs are not included in the standard EIS Kit. Please contact Electroair or one of our distributors for current pricing and availability of this spark plug.

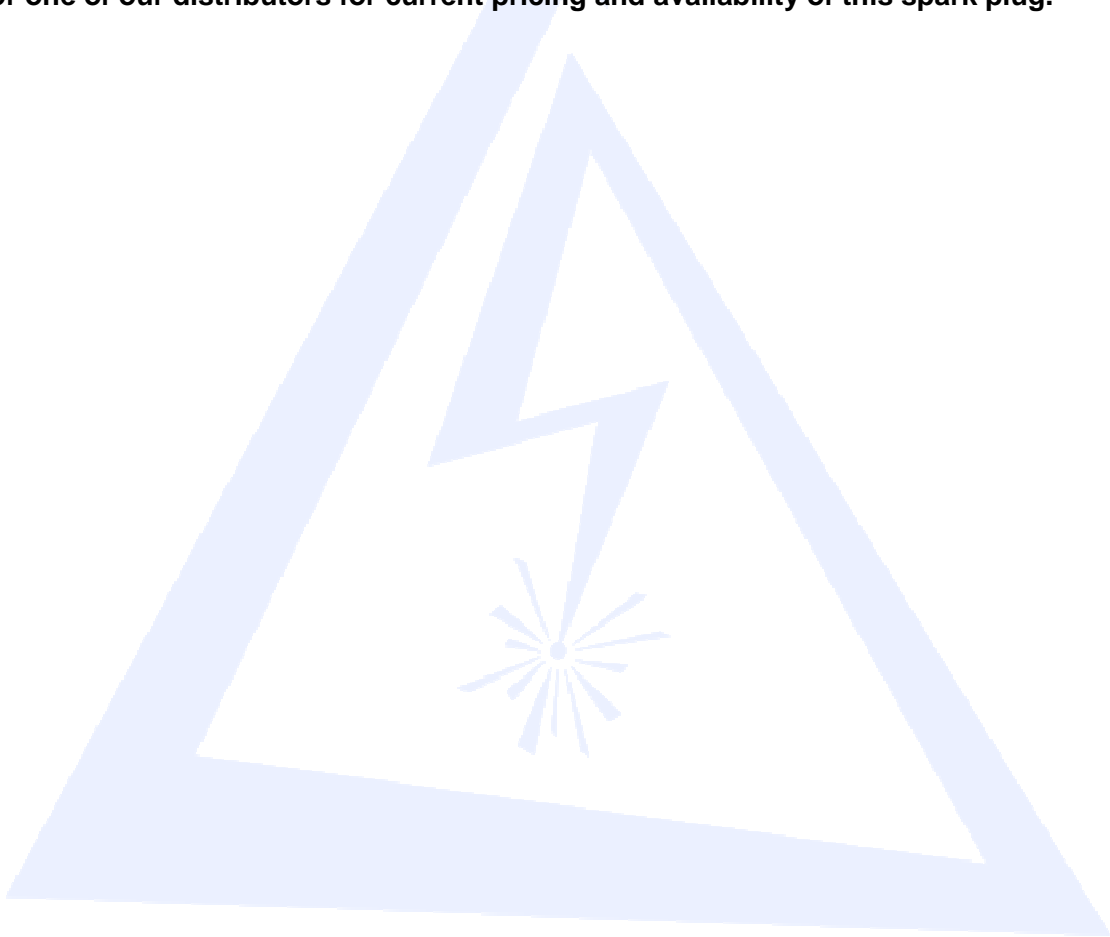

## ***Overview of Four Cylinder Single Engine Aircraft EIS Installation***

Thank you for purchasing an Electroair Ignition System for your aircraft. We are confident that you will be happy with the performance of this EIS on your aircraft. The next several pages will take you step-by-step through the process of installing this EIS on your aircraft. We hope you will enjoy the experience and that this manual will provide you with clear direction and guidance through this process. This manual will cover the following general installation steps:

1. General overview and recommendations
2. Removal of old ignition components
3. Set-up & Installation of p/n: EA-3000 MTH (EIS-41000 Kit Only)
4. Set-up & Installation of p/n: EA-3000IC Impulse Coupled MTH (EIS-41000IC Kit Only)
5. Installation of p/n: EA-1000 EIS Controller and p/n: EA-2000 Coil Pack
6. Installation of p/n: EA-5000 MAP Sensor
7. Installation of p/n: EA-4000 Spark Plug Harness
8. Connection of p/n: EA-6000 Wiring Harness
9. Final installation steps
10. Installation Options available from Electroair

We strongly recommend that you read through this entire installation procedure before installing your new EIS on your aircraft. Make sure that any questions you might have are answered before the actual installation. Also, make sure any extra components that you might need, e.g. cable ties, circuit breakers, switch terminations, etc., are all available. Removal of old components and installation of new components is to be completed in compliance with CFR Title 14 Part 43, as applicable, and any Airframe or Engine Manufacturer Maintenance Procedures, as applicable. Above all else, use good common sense and professional judgment. An electronic ignition system is a high voltage device. If an EIS is improperly installed or miss-fired, you could cause severe damage to the EIS, your aircraft, or even yourself.

Please contact us if you have any questions during this installation process. Good luck and happy flying!!

Electroair

## ***Installation of EIS-41000 & EIS-41000IC***

### **1. General Overview and Recommendations:**

- a Read through the entire installation instructions before beginning the installation to make sure you understand each step. **CALL US** if you have any questions or if there are any items that are unclear.
- b The installation of the EIS should take between 6 - 10 hours, depending on your skill set for working on the engine & ignition systems.
- c Review your own skill set. This ignition system is designed to be installed by aviation professionals with the appropriate ratings and experience for maintaining General Aviation aircraft.
- d When installing all EIS-41000 components, if preexisting components on the airframe are in the way of or are in close proximity to the installation locations follow these 2 measures. **Note:** When making **ANY** changes or modifications to the aircraft or aircraft components, make sure all practices are in accordance with CFR Title 14 Part 43.
  - i If the preexisting components can be relocated, move the components to an acceptable location on the airframe where they will not come into contact with the EIS component(s).
  - ii If the preexisting components must come into contact or close proximity to the EIS component(s), make sure to protect all components from each other. This could mean, but not limited to, adding anti-chafing material, additional component securing devices, heat shielding material, etc.
- e Always use good safety and work practices. Use appropriate safety equipment (glasses, etc.) and precautions. The EIS is a high voltage system and if installed or tested incorrectly can cause substantial damage to both the system and YOU!

## 2. Removal of Old Ignition Components:

- a Remove cowling. Verify that Master Switch is off and battery is disconnected.
- b **IMPORTANT:** Determine which magneto you will be replacing, either the right or the left magneto and whether it is direct drive or impulse coupled magneto. **Note:** If you are replacing an impulse coupled magneto you will need the EIS-41000IC kit.
  - i If you are replacing a direct drive type magneto, this magneto will have single gear installed on its drive shaft. This gear will be reused to install p/n: EA-3000 MAG Timing Housing.
  - ii If you are replacing an impulse coupled magneto, this magneto will have an impulse coupler installed on its drive shaft and a drive gear installed on top of the impulse coupler. Both the impulse coupler and drive gear will be reused to install p/n: EA-3000IC Impulse Coupled MAG Timing Housing.
- c Remove ignition harness from the spark plugs associated with the magneto that is being replaced.
- d Disconnect the P-lead that is installed on the magneto that is being replaced from the ignition switch.
- e Remove the selected magneto, the selected magneto's ignition harness, and selected magneto's P-lead from ignition switch. Retain the magneto hold down clips; they will be used to install the MTH (either p/n: EA-3000 or p/n: EA-3000IC).
- f Remove the magneto drive components, as detailed in step 2.b, from the magneto. Be careful not to damage the drive components. We recommend using a standard gear puller. Retain drive components for installation of either p/n: EA-3000 or p/n: EA-3000IC.
- g Remove spark plugs if new plugs are going to be used (recommended) with the electronic ignition system.



### 3. Set-up & Installation of p/n: EA-3000 MTH (For EIS-41000 Kit Only):

- a Retrieve p/n: EA-3000 MTH and the EA-3000 MTH Hardware Kit.
- b Insert the woodruff key into the key slot on the MTH shaft.
- c Place the direct drive magneto gear on the MTH shaft. Be sure to align the Woodruff (half-moon shape) key with the slot in the gear.
- d Install the washer and nut onto the MTH shaft and tighten the nut to the same torque value as recommended by the magneto manufacturer (Bendix or Slick). Install the cotter pin through the castle nut and MTH shaft with the long end of the cotter pin facing you. Bend the long end of the cotter pin over the end of the shaft and the short end along the side of the nut. The direct drive gear is now installed onto the MTH shaft.
- e Holding the MTH, insert the alignment pin in the alignment hole on the back cover (pin supplied with hardware kit). Slowly turn the gear on the front of the unit until the alignment pin drops into a second hole inside the MTH. The MTH is now set to Top Dead Center (TDC) and you should NOT be able to spin the MTH shaft. Leave the alignment pin in the MTH and ready the engine for the MTH installation (next steps). See Figure 3.1 below for example.



Figure 3.1: Installation of MTH Alignment Pin

- f Clean magneto pad on the engine. Install new gasket on p/n: EA-3000.
- g **VERIFY MASTER SWITCH IS OFF AND BATTERY IS DISCONNECTED.**
- h Rotate the engine to Top Dead Center (TDC) for cylinder # 1. This done by rotating the prop ***in the direction of the engine rotation*** until TDC is reached. At TDC, the impulse coupler on the remaining magneto should click. Verify TDC using the timing marks found on the engine. Typically, the first set is on the fly wheel and the starter; they will line up at TDC; the second set may be another mark on the back-side of fly wheel which lines up with the engine case seam at TDC. If any of these indications are not correct, repeat this step until they are. ***Always rotate the engine in the direction that it rotates during operation.***
- i Install the MTH into the proper magneto hole. Secure the MTH using the mag holding clips referenced in step 2.e and secure per engine manufacturer specifications.
- j ***Remove the alignment pin.*** Failure to remove the MTH Alignment Pin may cause damage to the MTH, the engine, or both.
- k P/N EA-3000 is now installed and timed properly.

#### 4. Set-up & Installation of p/n: EA-3000IC Impulse Coupled MTH (For EIS-41000IC Kit Only):

**Note: The Impulse Coupler in this installation is only being used as a spacer for the drive gear. The Impulse Coupler does NOT retard the timing of the EIS.**

- a Retrieve p/n: EA-3000IC Impulse Coupled MTH and the EA-3000IC Impulse Coupled MTH Hardware Kit.
- b Insert the woodruff key into the **CORRECT** key slot on the Impulse Coupled MTH shaft. **Note:** The Impulse Coupled MTH shaft has two key slots, one on the tapered portion of the shaft and one on a flat portion of the shaft. The **CORRECT** key slot to use on the Impulse Coupled MTH shaft will match up with the key slot on the shaft of the magneto being replaced. **Example:** If the magneto that is being replaced only has one key slot on the tapered portion of its shaft, you will only install a woodruff key into the key slot on the tapered portion of the Impulse Coupled MTH shaft. In this example, the key slot on the flat portion of the Impulse Coupled MTH does NOT have a woodruff key installed in it. See Figure 4.1 below for a picture of this example.



**Figure 4.1: Picture of Example Scenario from Step 4.b**  
**Note: Magnetic Sensor Removed for Clarity**

- c Install the Impulse Coupler on to the Impulse Coupled MTH shaft. Be sure to align the slot in the impulse coupler with the Woodruff key(s) on the shaft. See Figure 4.2 below for a picture of this step. **Note:** Make sure the impulse coupler spring is installed in the impulse coupler following the installation procedures that are defined by its manufacturer.



**Figure 4.2: Picture of Step 4.c**  
**Note: Magnetic Sensor Removed for Clarity**

- d Install the drive gear onto the installed impulse coupler using the same installation procedures that are defined by its manufacturer. See Figure 4.3 below for a picture of this step.



**Figure 4.3: Picture of Step 4.d**  
**Note: Magnetic Sensor Removed for Clarity**

- e Install the washer and nut onto the Impulse Coupled MTH shaft and tighten the nut to the same torque value as recommended by the magneto manufacturer (Bendix or Slick). Install the cotter pin through the castle nut and impulse coupled MTH shaft with the long end of the cotter pin facing you. Bend the long end of the cotter pin over the

end of the shaft and the short end along the side of the nut. The impulse coupler and drive gear are now installed onto the impulse coupled MTH shaft.

- f Holding the Impulse Coupled MTH, insert the alignment pin in the alignment hole on the back cover (pin supplied with hardware kit). Slowly turn the gear on the front of the unit until the alignment pin drops into a second hole inside the Impulse Coupled MTH. The impulse coupled MTH is now set to Top Dead Center (TDC) and you should NOT be able to spin the Impulse Coupled MTH shaft. Leave the alignment pin in the Impulse Coupled MTH and ready the engine for the Impulse Coupled MTH installation (next steps). See Figure 3.1 for an example.
- g Clean magneto pad on the engine. Install new gasket on p/n: EA-3000IC.
- h **VERIFY MASTER SWITCH IS OFF AND BATTERY IS DISCONNECTED.**
- i Rotate the engine to Top Dead Center (TDC) for cylinder # 1. This done by rotating the prop ***in the direction of the engine rotation*** until TDC is reached. Verify TDC using the timing marks found on the engine. Typically, the first set is on the fly wheel and the starter; they will line up at TDC; the second set may be another mark on the back-side of fly wheel which lines up with the engine case seam at TDC. If any of these indications are not correct, repeat this step until they are. ***Always rotate the engine in the direction that it rotates during operation.***
- j Install the Impulse Coupled MTH into the proper magneto hole. Secure the MTH using the MAG holding clips referenced in step 2.e and secure per engine manufacturer specifications.
- k ***Remove the alignment pin.*** Failure to remove the MTH Alignment Pin may cause damage to the Impulse Coupled MTH, the engine, or both.
- l P/N EA-3000IC is now installed and timed properly.

**5. Installation of p/n: EA-1000 EIS Controller and p/n: EA-2000 Coil Pack:**

- a **EA-1000 Installation:** Install p/n EA-1000 EIS Controller where temperatures will not exceed 150°F. Because of this, we recommend that the EIS Controller be mounted on the cockpit side of the firewall with the shortest practical distance from the coil pack for the wiring harness runs. Reference Figure 5.1 for controller dimensions.

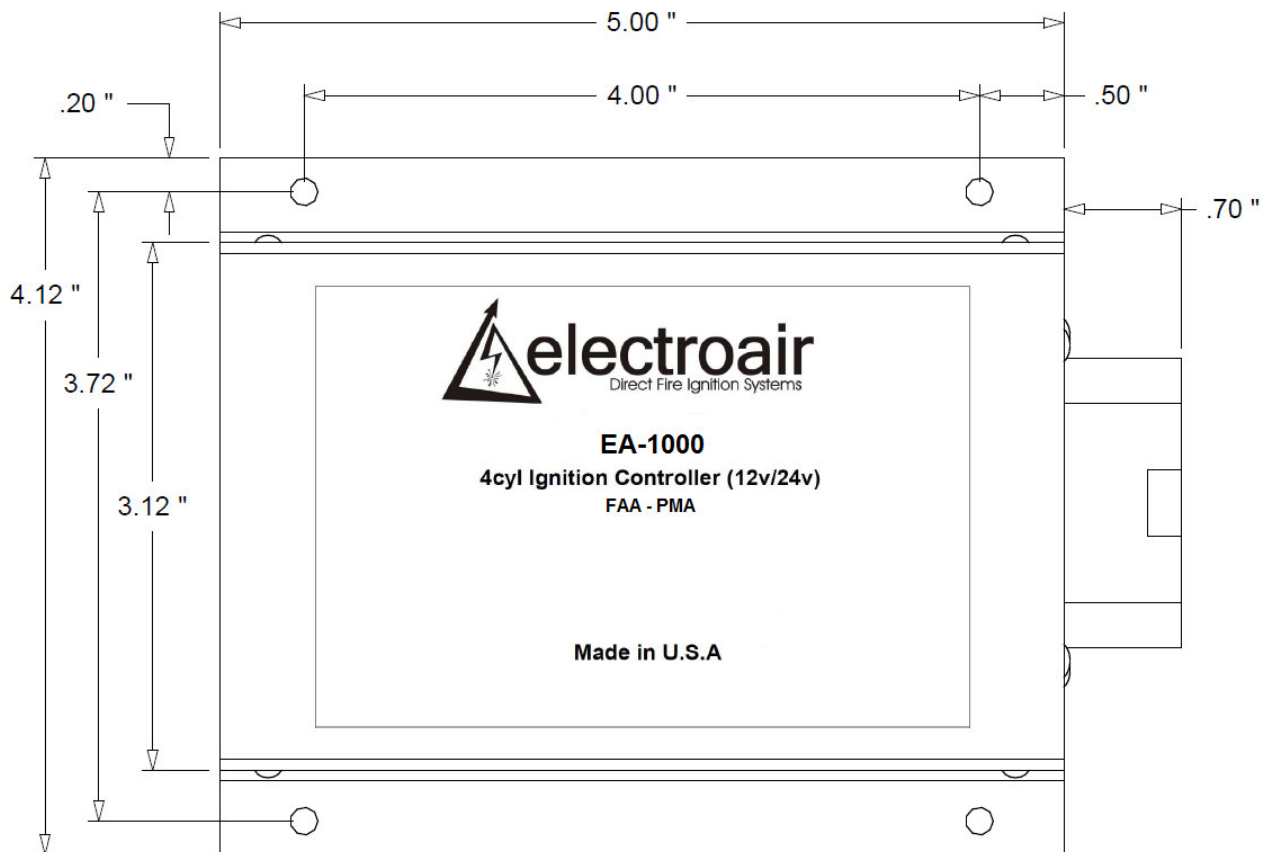

**Figure 5.1: P/N EA-1000 Overall and Hole Dimensions**

- b **EA-2000 Installation:** The coil pack is designed to be installed on the engine side of the firewall. Locate the unit in a position to keep the spark plug wires as short as possible and not interfere with other components or create maintenance difficulties in the future. Electroair strongly suggests that the Coil Pack be positioned so that the connector on the coil is facing straight down, but can be positioned in any orientation if the installation requires alternate positioning. See Figure 5.2 for the Coil Pack Dimensions.

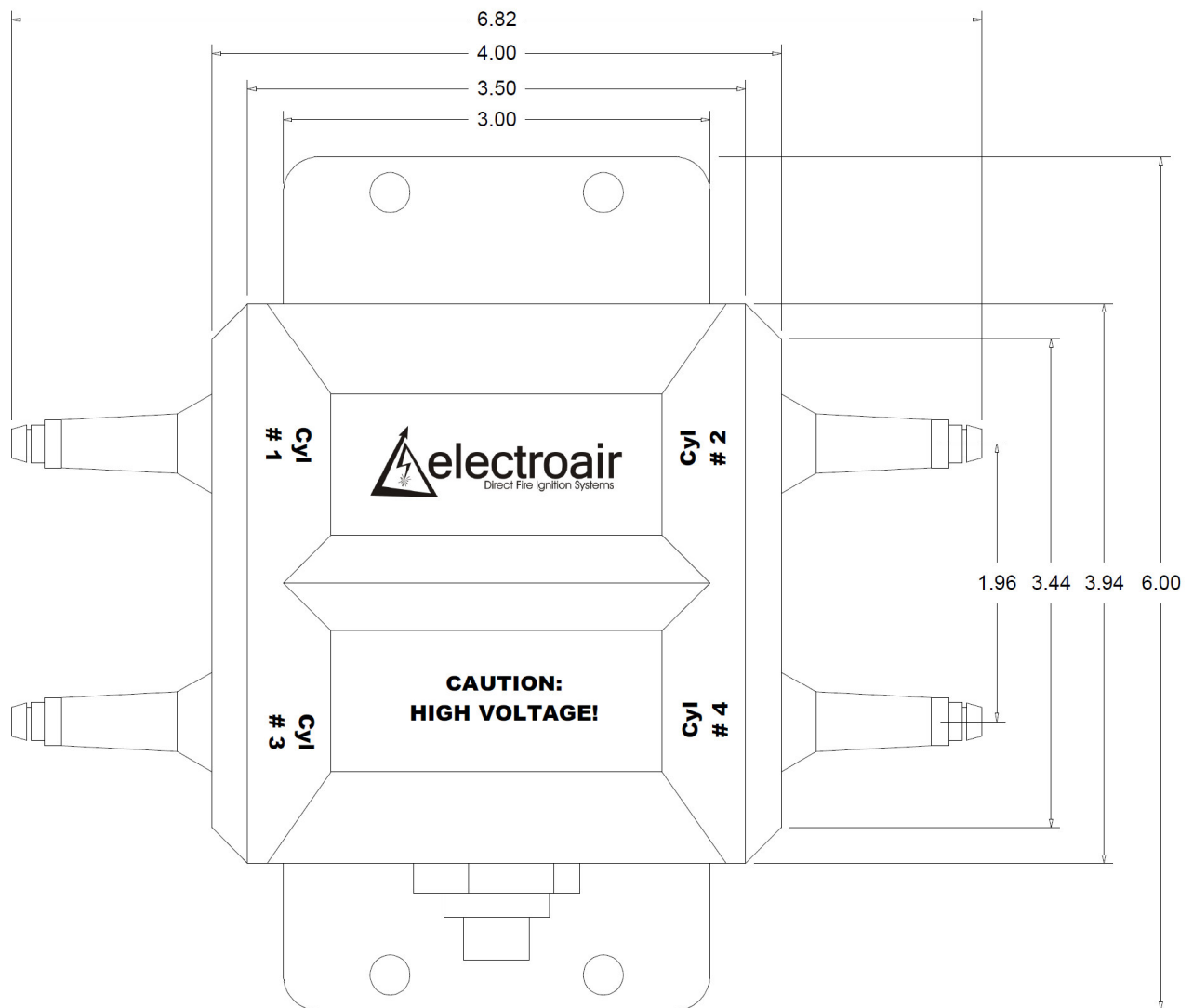
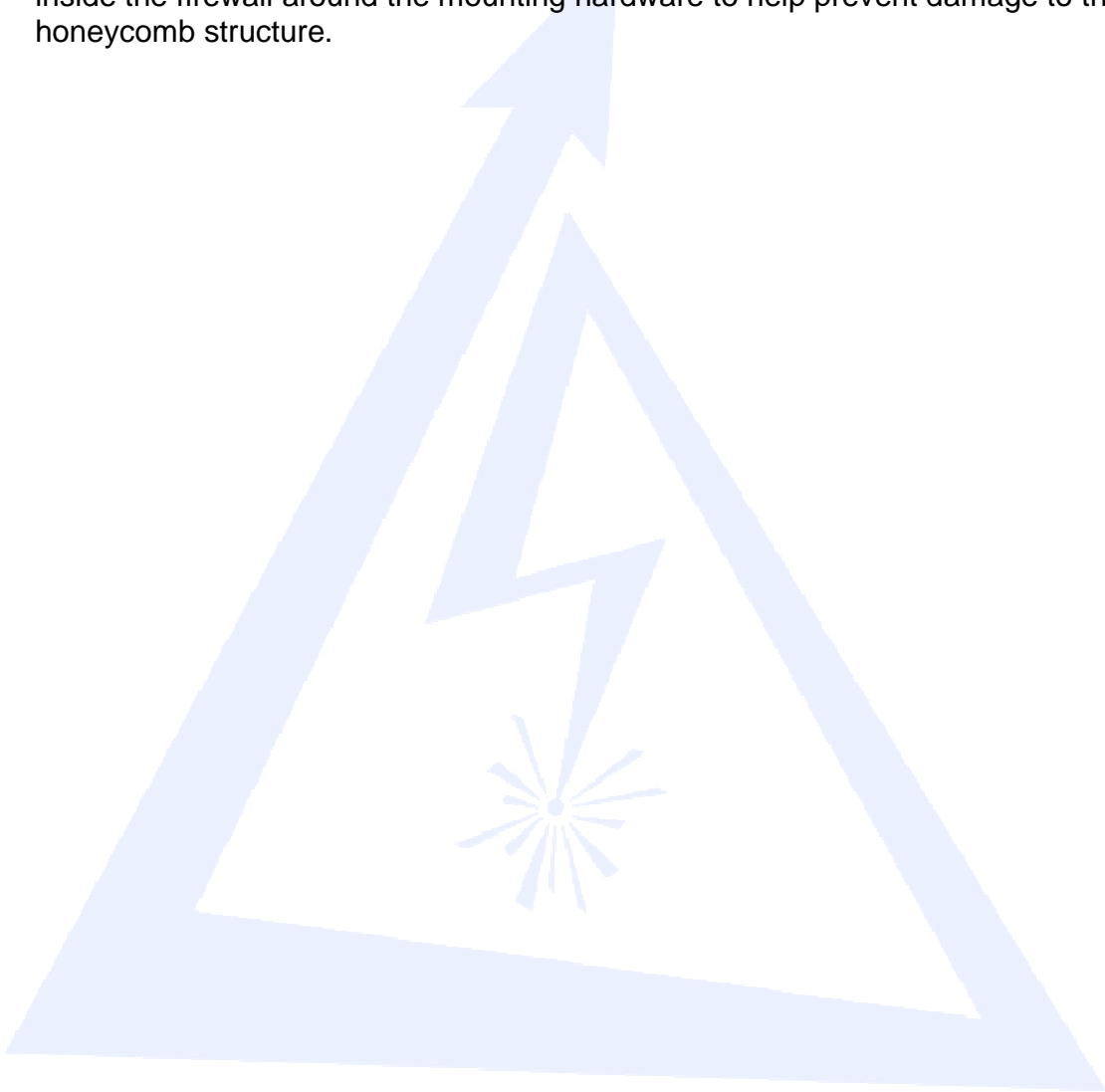

**Figure 5.2: P/N EA-2000 Dimensions**

- c. P/N EA-2000 comes with the mounting plate disassembled from the coil pack. This is done so the mounting plate can be used as a guide for easily locating mounting holes on the firewall. When locating the mounting holes on the firewall is completed, reinstall the plate to the coil pack following the procedure below:
- i. Obtain the mounting plate, coil pack, six mounting screws (MS24694S50), and Loctite #242 (included in the EIS-41000 kit box).
  - ii. Align the six clearance holes on the coil plate so that they line up with the six threaded inserts on the coil pack. Make sure that the countersink, on the plate, is facing outward.
  - iii. Apply a small drop of Loctite #242 to each of the coil mounting screws and install plate to coil pack. Make sure that that plate is straight and tighten screws (recommended torque value is 12-15 inch pounds).

**CAUTION: Prior to any drilling, verify that there is clearance from any components on both sides of the firewall.**

- d. After all considerations have been made regarding the placement of the controller and the coil pack, drill the mounting holes and install both units using standard AN hardware. **NOTES:**
- i To avoid any firewall cracking, place large washers between the firewall and fastening nuts to reinforce these contact points.
  - ii For honeycomb firewall installations, consider placing internal screw grommets inside the firewall around the mounting hardware to help prevent damage to the honeycomb structure.



## **6. Installation of p/n: EA-5000 MAP Sensor and Connection of Manifold Pressure Line:**

- a Verify that a manifold pressure line exists from the engine.
- b If a manifold pressure line does NOT exist, then you will need to install one in order to use p/n: EA-5000. **NOTE:** Use of p/n EA-5000 is optional. Leaving p/n: EA-5000 out of the system will simply cause the EIS to remain at a constant spark advance and not adjust spark timing for various manifold pressure readings, or altitude. This will reduce your fuel efficiency and the overall performance of the ignition system, but will not harm any engine components.
- c Locate an appropriate location to mount the MAP Sensor Preferably, this location should be inside the cockpit or somewhere where the temperatures will not exceed 150°F. Keep in mind all of the considerations that were mentioned in Step 5. Review step 5.a for installation notes.
- d Mount the MAP Sensor using standard AN type hardware.
  - i Mounting holes are sized for #6 fasteners. Use AN machine screws and either locking nuts or lock washers with plain nuts for installation.
  - ii Connect secondary ground to MAP Sensor. A secondary ground wire should be connected to the MAP Sensor where indicated (observe that paint has been removed from the bottom side of the MAP Sensor case, showing the connection point).
- e Now connect the manifold pressure line to the MAP Sensor. Make sure the connection is tight.
  - i **CAUTION:** Be careful not to apply too much force to the MAP Sensor hose when connecting it to the aircraft's manifold pressure line. Improper forcing of the hose can cause internal damage to the MAP Sensor.
  - ii If a Manifold Pressure gauge is installed, you can "T" into the manifold pressure line that is feeding the Manifold Pressure gauge.
    - 1.) The hose coming from the MAP Sensor is MIL-H-5593 type hose commonly used in vacuum line installation (either Aeroquip 306 or Stratoflex 193). This size is -3 or 3/16"ID.
    - 2.) You may connect to your manifold pressure line with either standard fittings or other appropriate fittings for this application.
    - 3.) Verify that all connections and lines are tight and secure.
  - iii If a Manifold Pressure gauge is not installed and you have created a new manifold pressure line, connect that new line directly to the hose coming from the MAP Sensor using standard fittings. The hose coming from the MAP Sensor is MIL-H-5593 type hose commonly used in vacuum line installation (either Aeroquip 306 or Stratoflex 193). This size is -3 or 3/16"ID.



## 7. Installation of p/n: EA-4000 Spark Plug Harness:

- a You can now install the spark plugs that will be connected to the Electronic Ignition System. We recommend that you use new aircraft spark plugs. If you are re-using the old spark plugs, make sure that they are clean.
  - i **Optional:** Electroair has approved two wide gap aircraft spark plugs for use our Electronic Ignition Systems. These spark plugs are manufactured with the wider air gap Electroair recommends be used with the Electronic Ignition Systems. These Electroair spark plugs are not included in the standard EIS Kit. These plugs are only approved to be used with Electroair's Electronic Ignition Systems. The Electroair part numbers and descriptions for these plugs are below:
    - 1.) **EAREM37HE Massive Electrode Spark Plug:** This plug is Electroair's version of the standard REM37BY spark plug. The EAREM37HE plug is manufactured with a 0.036" air gap. The EAREM37HE spark plug can be installed on the engines that are approved for the REM37BY spark plug, but can only be operated by an Electroair EIS. Please contact Electroair or one of our distributors for current pricing and availability of this spark plug.
    - 2.) **EARHM38SE Single Fine Wire Spark Plug:** This plug is Electroair's version of the standard RHM38S spark plug. The EARHM38SE is manufactured with a 0.036" air gap. The EARHM38SE spark plug can be installed on the engines that are approved for the RHM38S spark plug, but can only be operated by an Electroair EIS. Please contact Electroair or one of our distributors for current pricing and availability of this spark plug.
  - ii For all other aircraft spark plugs, Electroair recommends that you open the gap of the spark plugs to 0.030" - 0.036". For Lycoming engines, we suggest using the REM37BY (or UREM37BY) spark plug because they are the easiest to gap. Check the engine application data to verify that these plugs can be used in your engine. **CAUTION:** Be careful when gapping all other plugs than the REM37BY (UREM37BY) plug, because the outer electrode can become over-stressed and break. If you have any problems with plug selection, please give us a call.
- b Your kit came with two spark plug wire bundles and an EA-4000 REM Hardware Kit. Each bundle will make two spark plug wires. **Note:** The EIS Kit comes with REM spark plug hardware. If you are using RHM spark plugs, please contact Electroair for RHM hardware replacements. **CAUTION:** Since each assembly makes two spark plug wires, be careful when determining spark plug wire length.
  - i Route the spark plug wire from the coil pack to the correct cylinder (See Coil Pack label for wire orientation) to determine the spark plug wire length. Make sure to keep spark plug wire routings away from exhaust pipes. Wires routed parallel to each other require a minimum of ¼" of separation.
  - ii Cut the spark plug wire leaving enough length to go three inches beyond the spark plug.
  - iii Slide the aluminum nut, receptacle, washer, and gasket on the wire. Approximately one inch of wire should extend past the gasket. See Figure 7.1 for the correct component stack-up.
  - iv The wire supplied is a spiral core wire with a non-conductive center (Kevlar fibers). Insert the spark plug spring on the inside of the spiral core so that the spring 'tail' makes contact with the spiral core. You should feel the spring 'tail' as it hits the

spiral core during the insertion. **CAUTION:** do not install the spring tail directly in the center of the Kevlar fibers as it will not make contact with the spiral core. **OPTIONAL:** you may strip ~1/8" of the ignition wire insulation to expose the spiral core wire to make installing the spring easier.

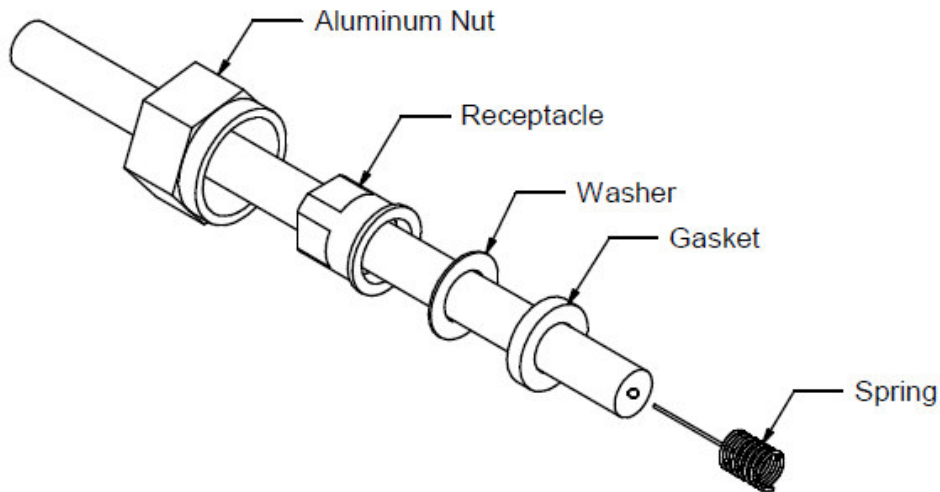

**Figure 7.1 Spark Plug Wire Hardware Assembly**

- v To finish the connection, install the spark plug end of the wire first. This prevents the spark plug wire from twisting as the spark plug nut is tightened. **CAUTION:** Do not over-tighten the spark plug nut as this may cause separation of the core of the wire. Tighten the spark plug nut to a torque value of 95 in-lb
- vi Attach the other end of the spark plug wires to the coil pack at their appropriate coil tower. **NOTE:** When you insert the 90° boot over each tower on the coil pack, you should hear an audible “SNAP” when the wire is properly installed onto each tower. If you do not hear this snap, remove the boot from the tower and repeat this step until you hear this “SNAP”.
- vii Coil towers are numbered on the coil pack: 1, 2, 3, and 4. Because of the nature of the system, coil towers 1 & 2 will fire simultaneously and then coil towers 3 & 4 will fire simultaneously.
- viii For Lycoming engines, hook-up the spark plug wires according to the following chart:

Coil Pack	Tower 1	Tower 2	Tower 3	Tower 4
Cylinder #	1	2	3	4

- ix The coil towers should be oriented towards the same side of the engine as the cylinders – this should make spark plug wire hook-up easier.

## **8. Connection of p/n: EA-6000 Wiring Harness:**

- a **Verify that the master switch is off and battery is disconnected.**
- b The electrical connections that will be made are as follows:
  - i. Harness to p/n: EA-1000, EIS Controller
  - ii. Harness to p/n: EA-5000, MAP Sensor
  - iii. Harness to p/n: EA-3000 (or EA-3000IC), MAG Timing Housing (MTH)
  - iv. Harness to p/n: EA-2000, Coil Pack
  - v. Harness to Switched Power & Ground for EIS Controller
  - vi. Harness to Ignition Switch (Rotary Switch Only)
  - vii. Harness to Tachometer
- c A small hole must be installed in the fire wall to route wires from the harness to their intended connections. We recommend a 1" diameter hole be drilled to provide clearance for the wire harnesses. A grommet, suggested p/n: MS35489-12, can be used to help seal off the firewall hole after the wire harness has been passed through the firewall.

**CAUTION: Prior to any drilling, verify that there is clearance from any components on both sides of the firewall.**

- d **NOTES:** The main harness is assembled so it can be installed through tight clearances such as a hole in the fire wall. You will need to supply terminations for switches, circuit breakers, and the bus bar. A wiring diagram with pin-out information has been supplied at the end of this section for reference. **CAUTION:** Follow these wiring instructions very carefully to insure a correct hook-up of your EIS. Skipping ahead or taking short cuts increases the risk of an incorrect installation and either a poor performing EIS or the possibility of damaging equipment. Please call us if you have any questions.
- e **Harness to p/n: EA-1000, EIS Controller:**
  - i Connect the wiring harness assembly to the EIS Controller. This is done by inserting the 23 pin female connector into the male header on the Controller. The harness is properly installed when the clip on the 23 pin connector is securing the connector to the header. You will begin routing the various harness bundles and wires from here.
- f **Harness to p/n: EA-5000, MAP Sensor:**
  - i Route the harness with the WHITE three pin connector to the MAP Sensor from the Controller.
  - ii Connect this connector to the MAP Sensor; loop any extra wire and secure with cable ties.
    - 1.) Attached to the connector end of the harness is a loose white and black striped wire. Connect this wire to any ground source. This can be connected to the Secondary Ground connection on the MAP Sensor.
- g **Harness to p/n: EA-3000 (or EA-3000IC), MAG Timing Housing (MTH):**
  - i Route the harness with the square BLACK three pin connector to the EA-3000 (or EA-3000IC if installing an EIS-41000IC) MTH.
  - ii From the already installed MTH, there will be a wire harness terminated with a female square BLACK three pin connector. See Figure 8.1 below.



Figure 8.1: MTH and 3 Pin Female Connector

- iii Connect connector from the routed harness to the connector on the MTH. Verify that the connection is secure.
- iv Loop any excess wire and secure with cable ties.
- h **Harness to p/n: EA-2000, Coil Pack:**
  - i Route the harness with the round BLACK connector to the Coil Pack. This harness is terminated with a round plug type connector. See Figure 8.2 below for how the harness should look.



Figure 8.2: Coil Pack Harness Plug

- ii Connect the connector from the harness to the mating connector on the Coil Pack.

- iii Route the unterminated end of the Red wire from the harness through a 10 amp breaker (fuses may be used as an alternative to the breaker) to the Essential Bus Bar. Trim and terminate as required.
- iv Loop any excess wire and cable tie or clamp the loop to a convenient location that does not interfere with any components (a location on the inside of the firewall is suggested).
- i **Harness to Switched Power & Ground for EIS Controller:**
  - i Go to the harness connector that is installed on the Controller.
  - ii Obtain the RED wire that is coming out of this connector.
  - iii Route the loose end of this RED wire to the panel for switch termination and circuit breaker termination (fuses may be used as an alternative to the breaker).
  - iv Trim & Terminate the Red wire to a panel mounted switch. Label this panel mounted switch "EIS Switch", and proper "ON/OFF" orientation. This switch should be a SPST switch.
  - v Connect this panel mounted switch to a 2 amp breaker or fuse.
  - vi Connect the 2 amp breaker or fuse to Essential Bus Bar.
  - vii Go to the harness connector that is installed on the Controller.
  - viii Obtain the 16 gauge Black wire, labeled "ELECTROAIR GROUND", that is coming out of this connector.
  - ix Trim & Terminate the Black wire to a competent aircraft ground.
  - x **IMPORTANT:** For aircraft that are using the "EIS Switch" as the ignition switch for the EIS-41000 (or EIS-41000IC) and not a Rotary Style Grounding switch, follow these procedures:
    - 1.) Go to the harness connector that is installed on the Controller.
    - 2.) Obtain the shielded WHITE wire, labeled "ELECTROAIR KEY SWITCH P-LEAD", which is coming out of this connector.
    - 3.) Trim this wire out of the connector and discard. **NOTE:** Be careful not to nick or cut any of the surrounding wires in the connector when trimming out this wire.
- j **Harness to Ignition Switch (Rotary Switch Only):**

**WARNING:** If installed, the P-LEAD wire for the EIS can only be connected to the aircraft's rotary style ignition switch. DO NOT install the EIS P-LEAD wire to any other starting accessory.

  - i This installation step is only necessary for aircraft that use a ROTARY STYLE ignition switch. For aircraft that use two separate ignition switches, the "EIS Switch" will be the ignition switch for the EIS-41000 (or EIS-41000IC). For aircraft that use two separate ignition switches, make sure to complete Installation step 9.b before starting the engine.
  - ii Go to the harness connector that is installed on the Controller.
  - iii Obtain the shielded WHITE wire, labeled "ELECTROAIR KEY SWITCH P-LEAD", which is coming out of this connector.
  - iv Trim and Terminate this shielded WHITE wire to the appropriate connection on the ignition switch. The appropriate connection on the ignition switch will be the connection that the replaced magneto P-lead was removed from. Use the same methods for terminating a Magneto P-Lead when terminating the EIS P-Lead.
    - 1.) **IMPORTANT:** Make sure the shield on the EIS P-Lead wire is grounded. Failure to ground this shield can cause the EIS to not operate properly.

k **Harness to Tachometer:**

- i Go to the harness connector that is installed on the Controller.
- ii Obtain the 22 gauge BLACK wire, labeled "ELECTROAIR TACHOMETER", that is coming out of this connector.
- iii The Tachometer output signal is a 12V or 24V (dependent on aircraft system voltage) square wave with two pulses per revolution. **CAUTION:** Verify that the Tachometer or engine monitor system that you are using can receive the above signal before connecting and operating. Incorrect signal types can cause incorrect readings or potentially damage monitoring systems.
- iv Route this BLACK wire to Tachometer or monitor system and install the lead as specified by the equipment manufacturer.
  - 1.) Loop any excess wire and cable tie or clamp the loop to a convenient location that does not interfere with any components
- v If you do not intend to use this output, then this bundle should be looped and tied to an appropriate place inside the cockpit for later use. Alternatively, this wire can be trimmed out of the harness connector if this option will never be used.

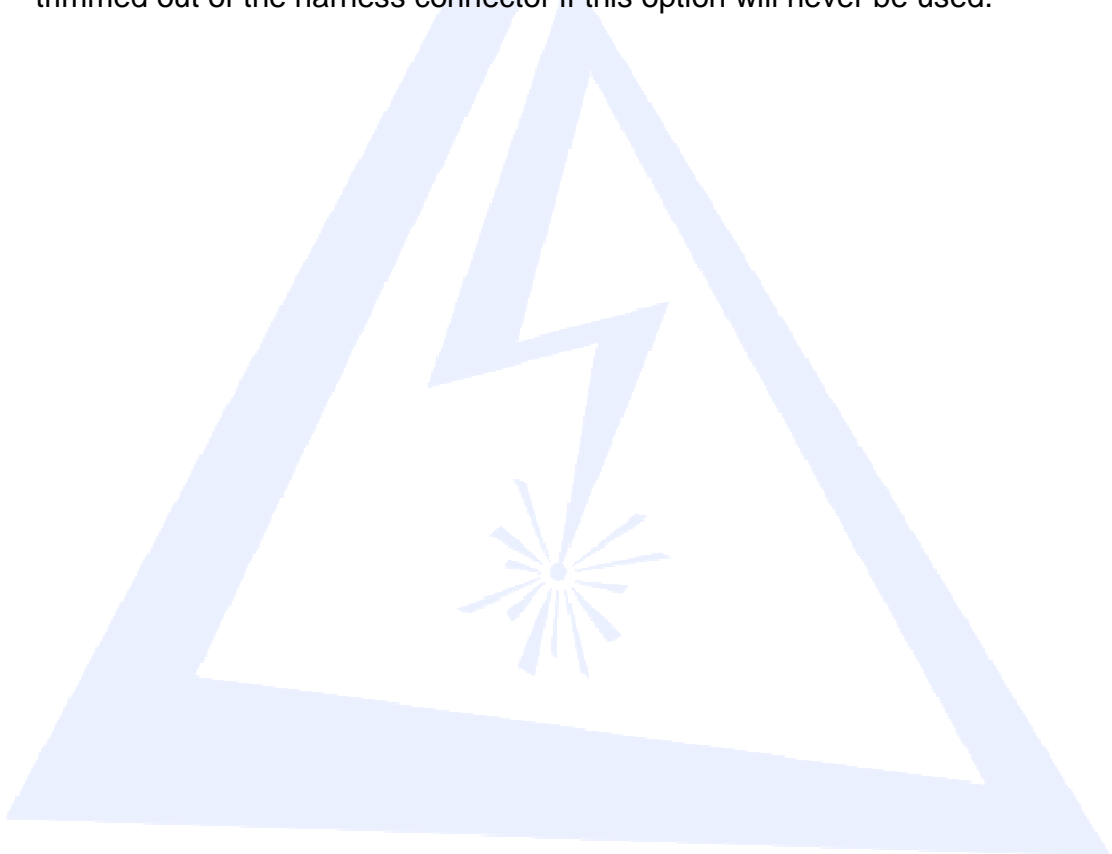

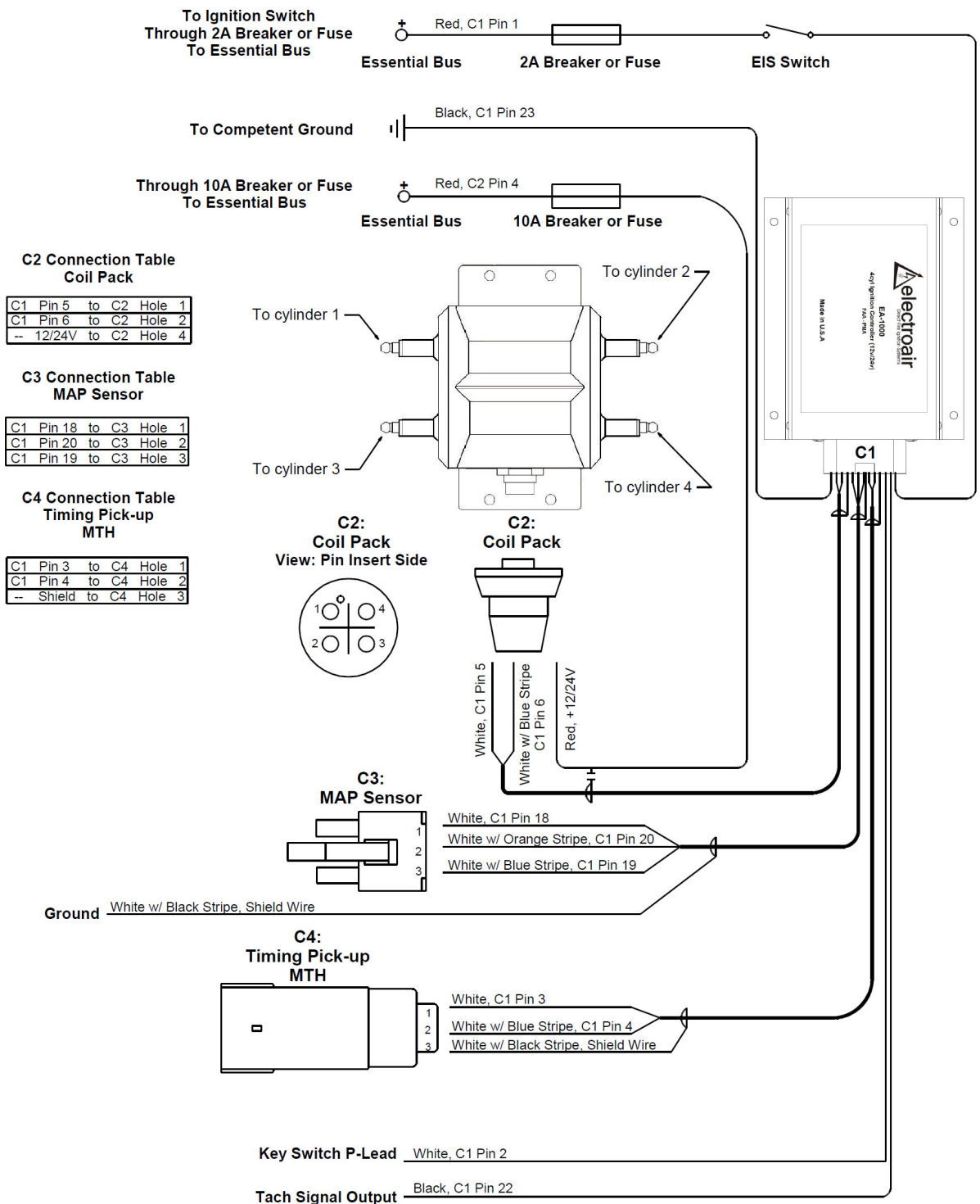

## Wiring Diagram for EIS-41000 & EIS-41000IC

## 9. Final Installation Steps:

- a Calibration and Timing settings: Your unit has been pre-set at the factory for a base timing of 25 deg BTDC (base timing is always placarded timing for the engine). Please contact us if you feel that your unit is not performing optimally, or if that base timing needs to be adjusted.
- b **IMPORTANT:** For aircraft that are using the “EIS Switch” as the ignition switch for the EIS-41000 (or EIS-41000IC) follow these procedures:
  - i. Go to the harness connector that is installed on the Controller.
  - ii. Obtain the shielded WHITE wire, labeled “ELECTROAIR KEY SWITCH P-LEAD”, which is coming out of this connector.
  - iii. Trim this wire out of the connector and discard. **NOTE:** Be careful not to nick or cut any of the surrounding wires in the connector when trimming out this wire.
- c Re-attach and reinstall any connections or components that were removed or loosened during this installation.
- d Secure all new wires, harness, connections and lines to prevent failures due to vibration.
- e Connect battery connections and close any open circuit breakers.
- f Recover all tools that may have been used (you don't want any tools 'floating' around inside the airplane).
- g Proceed to the operational section and perform a test run-up before flying.

## 10. Installation Options available from Electroair:

- a MTH Holders: You may use Slick p/n: K-3328
- b P/N: EAREM37HE. Electroair's Massive Electrode Spark Plug. This plug is Electroair's version of the standard REM37BY spark plug manufactured with a 0.036" air gap and has been approved for use with only Electroair's electronic ignition systems. These plugs come with the increased air gap Electroair recommends be used with our systems and eliminates the time and headache of re-gapping standard aircraft spark plugs. These Electroair spark plugs are not included in the standard EIS Kit. Please contact Electroair or one of our distributors for current pricing and availability of this spark plug.
- c P/N: EARHM38SE. Electroair's Single Fine Wire Spark Plug. This plug is Electroair's version of the standard RHM38S spark plug manufactured with a 0.036" air gap and has been approved for use with only Electroair's electronic ignition systems. These plugs come with the increased air gap Electroair recommends be used with our systems and eliminates the time and headache of re-gapping standard aircraft spark plugs. These Electroair spark plugs are not included in the standard EIS Kit. Please contact Electroair or one of our distributors for current pricing and availability of this spark plug.
- d Other options will be announced when available.



## ***Overview of Four Cylinder Twin Engine Aircraft EIS Installation***

Thank you for purchasing Electroair Electronic Ignition Systems, or EISs, for your twin engine aircraft. Electroair offers four optional EIS kits for four cylinder twin engine aircraft. These EIS kits differ in the type of magneto they replace. Listed below are the part numbers for each EIS kit and a brief description of which magneto is replaced by the EIS kits.

- **EIS-41000T:** This EIS kit replaces the NON-impulse coupled magneto on the standard rotating engine of a twin engine aircraft.
- **EIS-41000TIC:** This EIS kit replaces the impulse coupled magneto on the standard rotating engine of a twin engine aircraft.
- **EIS-41000TLH:** This EIS kit replaces the NON-impulse coupled magneto on the counter-rotating engine of a twin engine aircraft.
- **EIS-41000TLHIC:** This EIS kit replaces the impulse coupled magneto on the counter-rotating engine of a twin engine aircraft.

**EIS Kit Notes:** Only one EIS kit can be installed on each engine of a twin engine aircraft. Some twin engine aircraft do NOT have a counter-rotating engine, for that reason the EIS kits designated with an “LH” in their part number are not eligible for these aircraft type. The same part number EIS kit does NOT have to be installed on both engines on the twin engine aircraft.

The next several pages will take you step-by-step through the process of installing both EISs on your aircraft. We hope that this manual will provide you with clear direction and guidance through this process. This manual will cover the following general installation steps:

1. General Overview and Recommendations
2. Removal of Old Ignition Components
3. Set-up & Installation of p/n: EA-3000 MTH (EIS-41000T Kit Only) and EA-3000LH MTH (EIS-41000TLH Kit Only)
4. Set-up & Installation of p/n: EA-3000IC MTH (EIS-41000TIC Kit Only) and EA-3000LHIC MTH (EIS-41000TLHIC Kit Only)
5. Installation of p/n: EA-1000 EIS Controllers and p/n: EA-2000 Coil Packs
6. Installation of p/n: EA-5000 MAP Sensors
7. Installation of p/n: EA-4000 Spark Plug Harnesses
8. Connection of p/n: EA-6000T Twin Engine Wiring Harnesses
9. Instrument Panel EIS Labeling
10. Final Installation Steps
11. Installation Options Available from Electroair

We strongly recommend that you read through this entire installation procedure before installing your new EISs on your aircraft. Make sure that any questions you might have are answered before the actual installation. Also, make sure any extra components that you might need, e.g. cable ties, circuit breakers, switch terminations, etc., are all available. Removal of old components and installation of new components is to be completed in compliance with CFR Title 14 Part 43, as applicable, and any Airframe or Engine Manufacturer Maintenance Procedures, as applicable. Above all else, use good common sense and professional judgment. An electronic ignition system is a high voltage device. If an EIS is improperly installed or miss-fired, you could cause severe damage to the EIS, your aircraft, or even yourself.

Please contact us if you have any questions during this installation process. Good luck and happy flying!!

Electroair

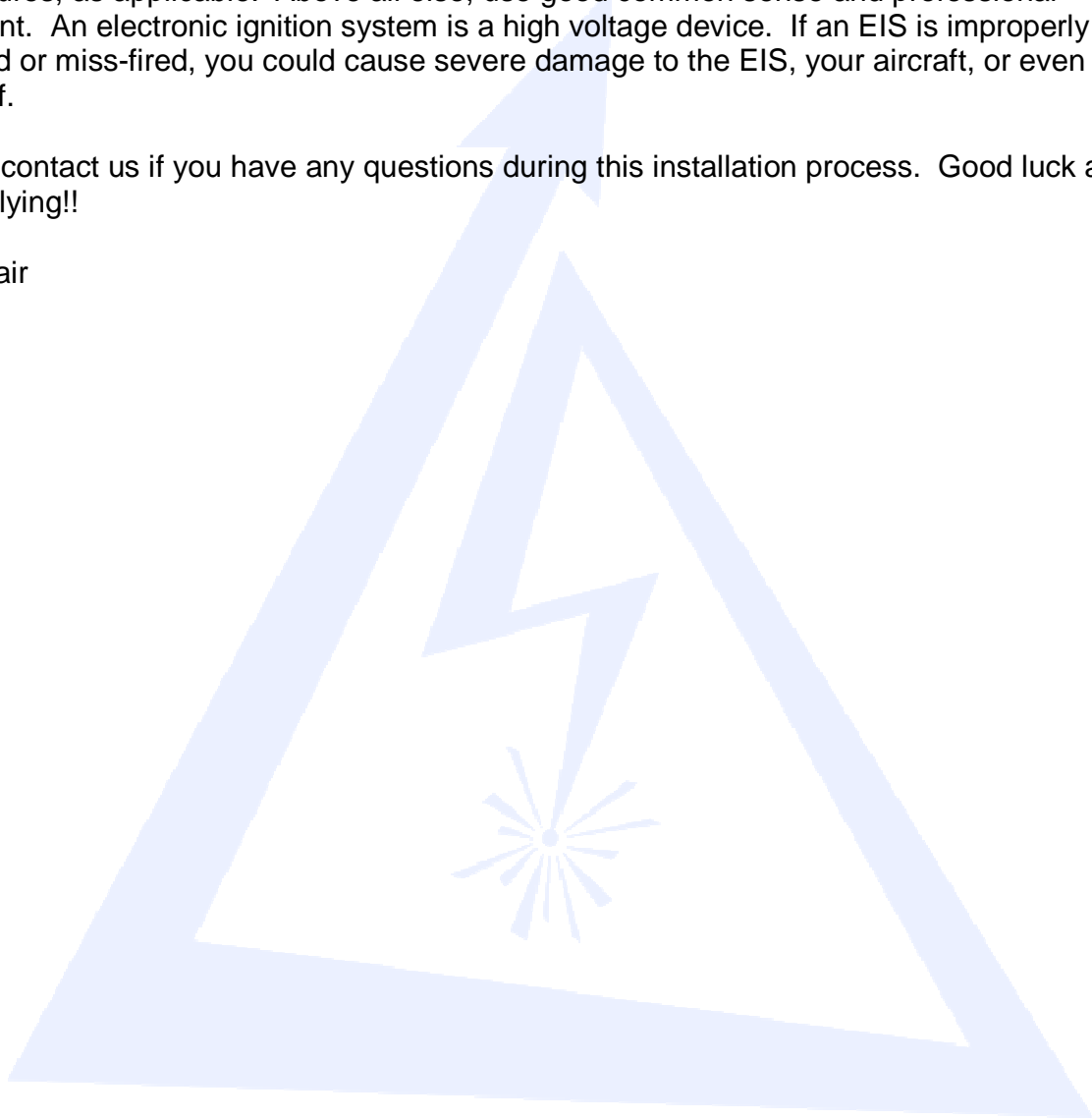

## ***Installation of EIS-41000T, EIS-41000TIC, EIS-41000TLH, & EIS-41000TLHIC***

### **1. General Overview and Recommendations:**

- a Read through the entire installation instructions before beginning the installation to make sure you understand each step. **CALL US** if you have any questions or if there are any items that are unclear.
- b The installation of both EISs should take between 12 - 16 hours, depending on your skill set for working on the engine & ignition systems.
- c Review your own skill set. This ignition system is designed to be installed by aviation professionals with the appropriate ratings and experience for maintaining General Aviation aircraft.
- d When installing all EIS components, if preexisting components on the airframe are in the way of or are in close proximity to the installation locations follow these two measures. **Note:** When making **ANY** changes or modifications to the aircraft or aircraft components, make sure all practices are in accordance with CFR Title 14 Part 43.
  - i If the preexisting components can be relocated, move the components to an acceptable location on the airframe where they will not come into contact with the EIS component(s).
  - ii If the preexisting components must come into contact or close proximity to the EIS component(s), make sure to protect all components from each other. This could mean, but not limited to, adding anti-chafing material, additional component securing devices, heat shielding material, etc.
- e Always use good safety and work practices. Use appropriate safety equipment (glasses, etc.) and precautions. The EIS is a high voltage system and if installed or tested incorrectly can cause substantial damage to both the system and YOU!

## 2. Removal of Old Ignition Components:

- a Remove cowlings. Verify that Master Switch is off and battery is disconnected.
- b **IMPORTANT:** Determine which magnetos you will be replacing, either the right or the left magneto, whether it is direct drive or impulse coupled magneto, and whether it is for a standard or counter-rotating engine.
  - i If you are replacing a direct drive type magneto, this magneto will have single gear installed on its drive shaft. This gear will be reused to install either p/n: EA-3000 or EA-3000LH.
  - ii If you are replacing an impulse coupled magneto, this magneto will have an impulse coupler installed on its drive shaft and a drive gear installed on top of the impulse coupler. Both the impulse coupler and drive gear will be reused to install either p/n: EA-3000IC or EA-3000LHIC.
- c Remove ignition harnesses from the spark plugs associated with the magnetos that are being replaced.
- d Disconnect both magneto P-leads from their respective ignition switches. **Note:** These ignition switches will be used later in the installation of the EIS Wiring Harnesses.
- e Remove the selected magnetos, the selected magnetos' ignition harnesses, and selected magnetos' P-leads from both the engines and the airframe. Retain the magneto hold down clips; they will be used to install the MTH (either p/n: EA-3000, EA-3000LH, EA-3000IC, or EA-3000LHIC).
- f Remove the magneto drive components, as detailed in step 2.b, from each magneto. Be careful not to damage the drive components. We recommend using a standard gear puller. Retain drive components for installation of either p/n: EA-3000, EA-3000LH, EA-3000IC, or EA-3000LHIC.
- g Remove spark plugs if new plugs are going to be used (recommended) with the electronic ignition systems.

### **3. Set-up & Installation of p/n: EA-3000 MTH (EIS-41000T Kit Only) and EA-3000LH MTH (EIS-41000TLH Kit Only):**

- a Retrieve either p/n: EA-3000 or EA-3000LH and the EA-3000 Hardware Kit, depending on which EIS kit you are installing.
- b Insert the woodruff key into the key slot on the MTH shaft.
- c Place the direct drive magneto gear on the MTH shaft. Be sure to align the woodruff key with the slot in the gear.
- d Install the washer and nut onto the MTH shaft and tighten the nut to the same torque value as recommended by the magneto manufacturer (Bendix or Slick). Install the cotter pin through the castle nut and MTH shaft with the long end of the cotter pin facing you. Bend the long end of the cotter pin over the end of the shaft and the short end along the side of the nut. The direct drive gear is now installed onto the MTH shaft.
- e Holding the MTH, insert the alignment pin in the alignment hole on the back cover (pin supplied with hardware kit). Slowly turn the gear on the front of the MTH until the alignment pin drops into a second hole inside the MTH. The MTH is now set to Top Dead Center (TDC) and you should NOT be able to spin the MTH shaft. Leave the alignment pin in the MTH and ready the engine for the MTH installation (next steps). See Figure 3.1 below for example.



Figure 3.1: Installation of MTH Alignment Pin on an EA-3000 MTH

- f Clean magneto pad on the engine. Install new gasket on the MTH.
- g **VERIFY MASTER SWITCH IS OFF AND BATTERY IS DISCONNECTED.**
- h Rotate the engine to Top Dead Center (TDC) for cylinder # 1. This done by rotating the prop ***in the direction of the engine rotation*** until TDC is reached. At TDC, the impulse coupler on the remaining magneto should click. Verify TDC using the timing marks found on the engine. Typically, the first set is on the fly wheel and the starter; they will line up at TDC; the second set may be another mark on the back-side of fly wheel which lines up with the engine case seam at TDC. If any of these indications are not correct, repeat this step until they are. ***Always rotate the engine in the direction that it rotates during operation.***
- i Install the MTH into the proper magneto hole. Secure the MTH using the mag holding clips referenced in step 2.e and secure per engine manufacturer specifications.
- j ***Remove the alignment pin.*** Failure to remove the MTH Alignment Pin may cause damage to the MTH, the engine, or both.
- k P/N EA-3000 or EA-3000LH is now installed and timed properly.

- I Repeat these steps for the second engine on the airframe if you are installing either p/n: EA-3000 or EA-3000LH on that engine.

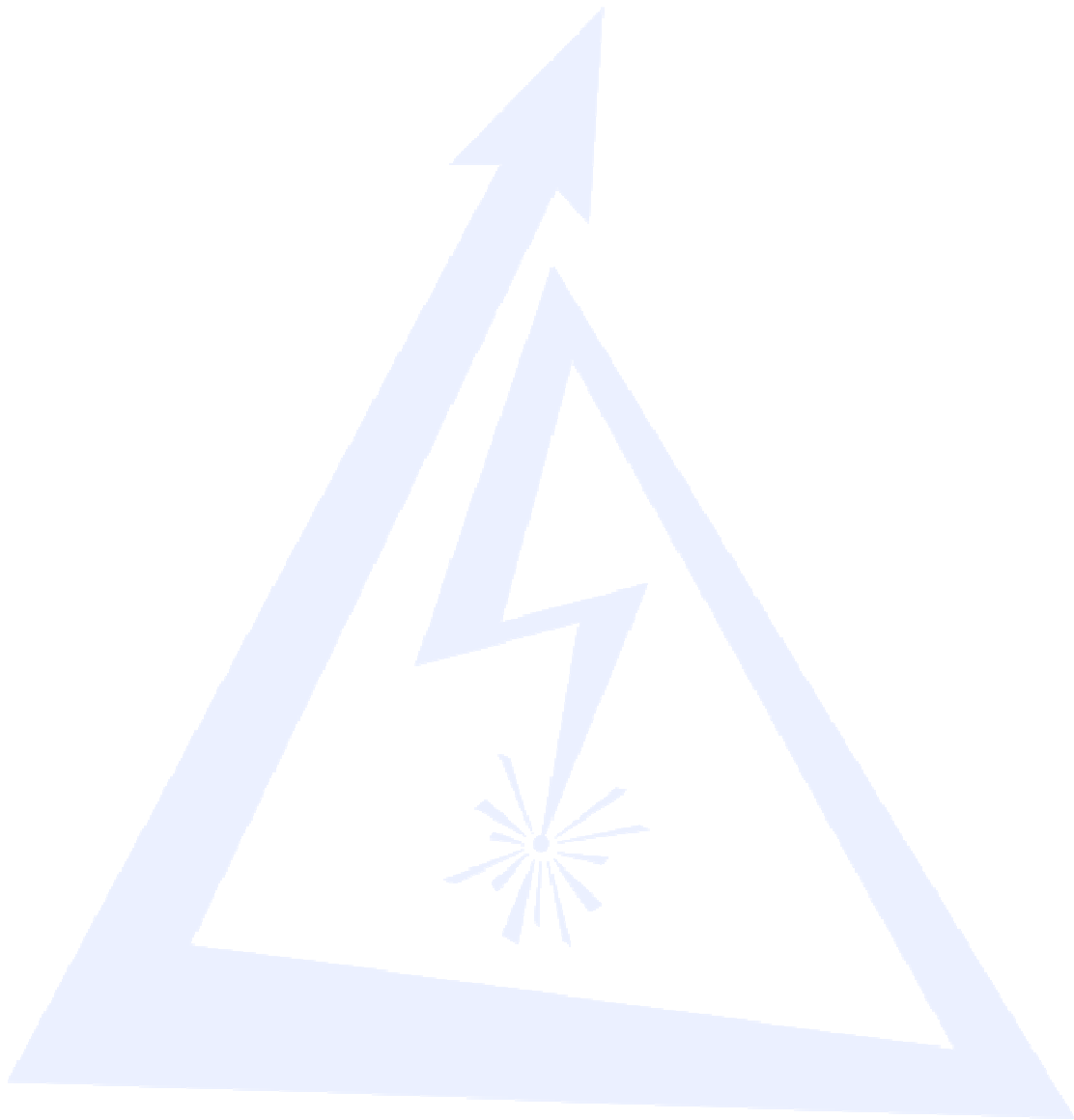

4. **Set-up & Installation of p/n: EA-3000IC MTH (EIS-41000TIC Kit Only) and EA-3000LHIC MTH (EIS-41000TLHIC Kit Only):**

**Note: The Impulse Coupler in this installation is only being used as a spacer for the drive gear. The Impulse Coupler does NOT retard the timing of the EIS.**

- a Retrieve either p/n: EA-3000IC or EA-3000LHIC and the EA-3000IC Hardware Kit, depending on which EIS kit you are installing.
- b Insert the woodruff key into the **CORRECT** key slot on the Impulse Coupled MTH shaft. **Note:** The Impulse Coupled MTH shaft has two key slots, one on the tapered portion of the shaft and one on a flat portion of the shaft. The **CORRECT** key slot to use on the Impulse Coupled MTH shaft will match up with the key slot on the shaft of the magneto being replaced. **Example:** If the magneto that is being replaced only has one key slot on the tapered portion of its shaft, you will only install a woodruff key into the key slot on the tapered portion of the Impulse Coupled MTH shaft. In this example, the key slot on the flat portion of the Impulse Coupled MTH does NOT have a woodruff key installed in it. See Figure 4.1 below for a picture of this example.



**Figure 4.1: Picture of Example Scenario from Step 4.b**  
**Note: Magnetic Sensor Removed for Clarity**

- c Install the Impulse Coupler on to the Impulse Coupled MTH shaft. Be sure to align the slot in the impulse coupler with the Woodruff key(s) on the shaft. See Figure 4.2 below for a picture of this step. **Note:** Make sure the impulse coupler spring is installed in the impulse coupler following the installation procedures that are defined by its manufacturer.



**Figure 4.2: Picture of Step 4.c**  
**Note: Magnetic Sensor Removed for Clarity**

- d Install the drive gear onto the installed impulse coupler using the same installation procedures that are defined by its manufacturer. See Figure 4.3 below for a picture of this step.



**Figure 4.3: Picture of Step 4.d**  
**Note: Magnetic Sensor Removed for Clarity**

- e Install the larger O.D. washer, the smaller O.D. washer, and castle nut onto the Impulse Coupled MTH shaft in this order. Tighten the nut to the same torque value as recommended by the magneto manufacturer (Bendix or Slick). Install the cotter pin



through the castle nut and impulse coupled MTH shaft. The impulse coupler and drive gear are now installed onto the impulse coupled MTH shaft.

- f Holding the Impulse Coupled MTH, insert the alignment pin in the alignment hole on the back cover (pin supplied with hardware kit). Slowly turn the gear on the front of the MTH until the alignment pin drops into a second hole inside the Impulse Coupled MTH. The impulse coupled MTH is now set to Top Dead Center (TDC) and you should NOT be able to spin the Impulse Coupled MTH shaft. Leave the alignment pin in the Impulse Coupled MTH and ready the engine for the Impulse Coupled MTH installation (next steps). See Figure 3.1 for an example.
- g Clean magneto pad on the engine. Install new gasket on impulse coupled MTH.
- h **VERIFY MASTER SWITCH IS OFF AND BATTERY IS DISCONNECTED.**
- i Rotate the engine to Top Dead Center (TDC) for cylinder # 1. This done by rotating the prop ***in the direction of the engine rotation*** until TDC is reached. Verify TDC using the timing marks found on the engine. Typically, the first set is on the fly wheel and the starter; they will line up at TDC; the second set may be another mark on the back-side of fly wheel which lines up with the engine case seam at TDC. If any of these indications are not correct, repeat this step until they are. ***Always rotate the engine in the direction that it rotates during operation.***
- j Install the Impulse Coupled MTH into the proper magneto hole. Secure the MTH using the MAG holding clips referenced in step 2.e and secure per engine manufacturer specifications.
- k ***Remove the alignment pin.*** Failure to remove the MTH Alignment Pin may cause damage to the Impulse Coupled MTH, the engine, or both.
- l P/N EA-3000IC or EA-3000LHIC is now installed and timed properly.
- m Repeat these steps for the second engine on the airframe if you are installing either p/n: EA-3000IC or EA-3000LHIC on that engine.

**5. Installation of p/n: EA-1000 EIS Controllers and p/n: EA-2000 Coil Packs:**

- a **EA-1000 Installation:** Install both p/n: EA-1000 EIS Controllers where temperatures will not exceed 150°F. Because of this, we recommend that the EIS Controllers be mounted somewhere inside the cabin with the shortest practical distance from their respective coil packs for the wiring harness runs. Note: Some twin engine airframes have open space inside the nose of the airframe. The controller could be placed on the nose side of the bulkhead which separates the cabin from the nose. Reference Figure 5.1 for controller dimensions.

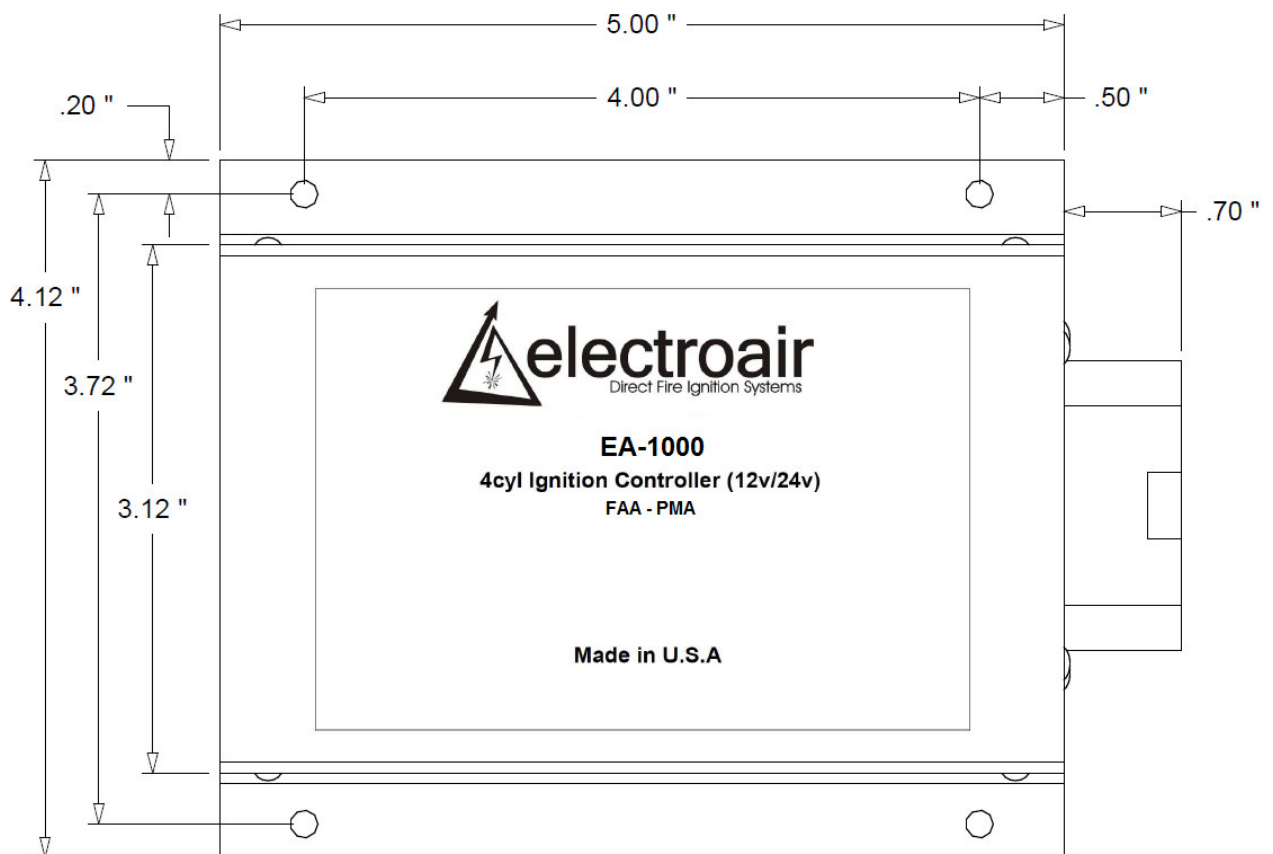

**Figure 5.1: P/N EA-1000 Overall and Hole Dimensions**

- b. **EA-2000 Installation:** The coil pack is designed to be installed on the engine side of the firewall. Establish coil pack installation locations on both engine firewalls that will keep the spark plug wires as short as possible, keep clearance between the coil pack and other components, and not create maintenance difficulties in the future. Electroair strongly suggests that the Coil Pack be positioned so that the connector on the coil is facing straight down, but can be positioned in any orientation if the installation requires alternate positioning. See Figure 5.2 for the Coil Pack Dimensions.

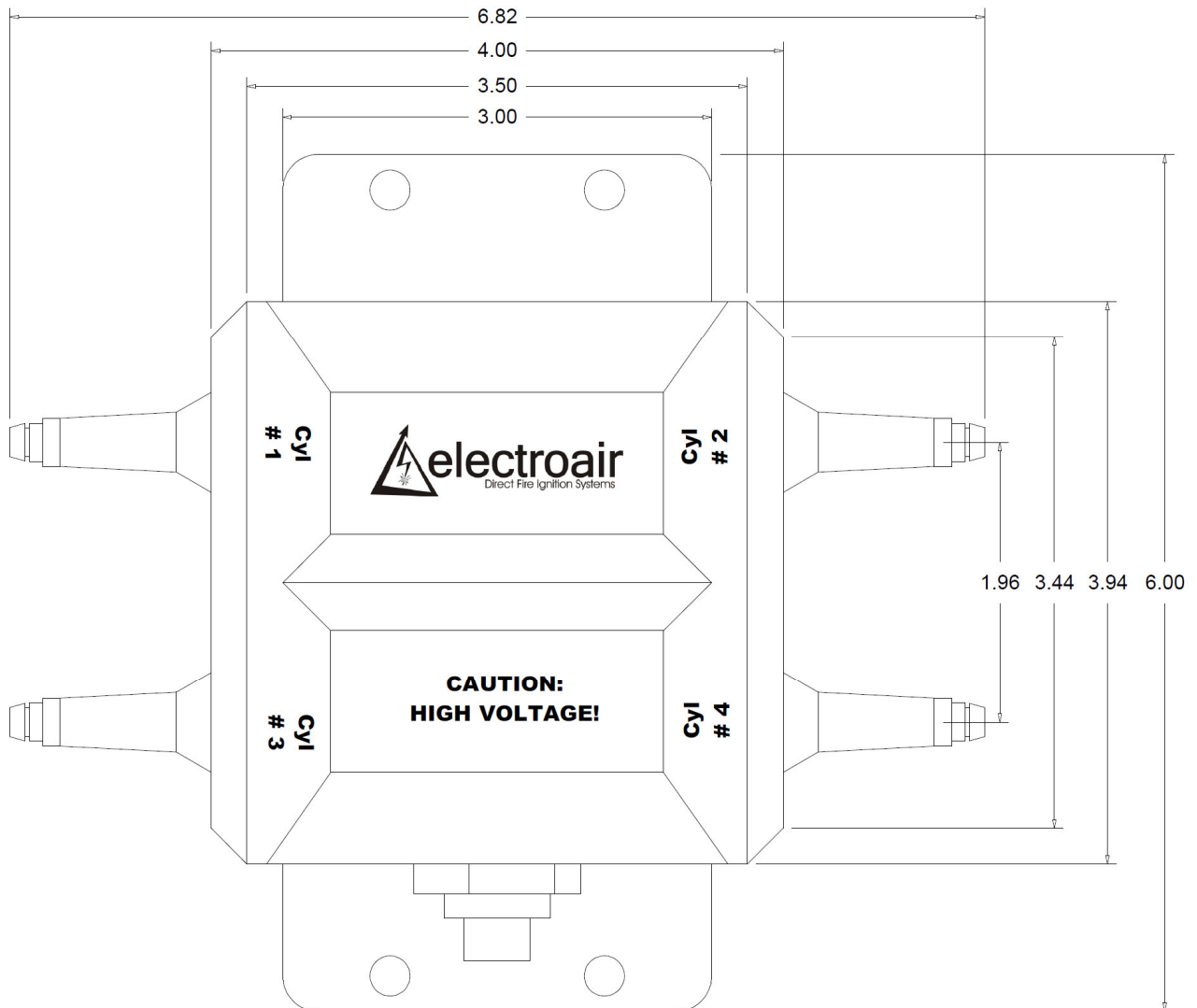

Figure 5.2: P/N EA-2000 Dimensions

- c. P/N EA-2000 comes with the mounting plate disassembled from the coil pack. This is done so the mounting plate can be used as a guide for easily locating mounting holes on the firewalls. When locating the mounting holes on each firewall is completed, install each plate onto to its coil pack following the procedure below:
- i. Obtain the mounting plate, coil pack, six mounting screws (MS24694S50), and Loctite #242 (included in the EIS kit box).

- ii. Align the six clearance holes on the coil plate so that they line up with the six threaded inserts on the coil pack. Make sure that the countersink, on the plate, is facing outward.
- iii. Apply a small drop of Loctite #242 to each of the coil mounting screws and install each screw through the plate to threads in the coil pack. Make sure that the plate is straight and tighten screws (recommended torque value is 12-15 inch pounds).

**CAUTION: Prior to any drilling, verify that there is clearance from any components on both sides of each firewall.**

- d. After all considerations have been made regarding the placement of the controllers and the coil packs, drill the mounting holes and install all four components using standard AN hardware. **NOTES:**
  - i. To avoid any firewall cracking, place large washers between the firewall and fastening nuts to reinforce these contact points.
  - ii. For honeycomb firewall installations, consider placing internal screw grommets inside the firewall around the mounting hardware to help prevent damage to the honeycomb structure.

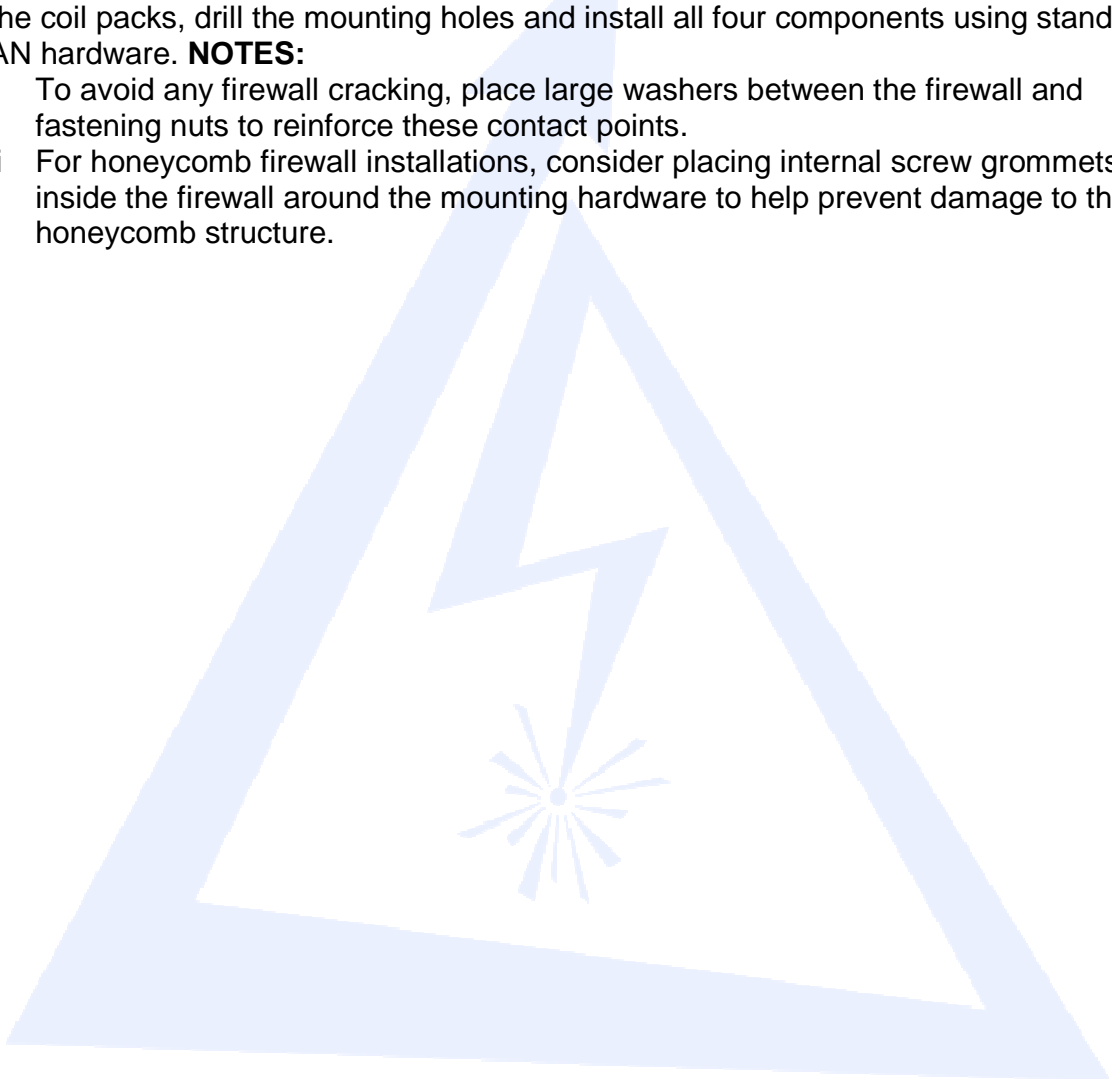

## **6. Installation of p/n: EA-5000 MAP Sensors and Connection of Manifold Pressure Lines:**

- a Verify that a manifold pressure lines exists from both engines.
- b If manifold pressure lines do NOT exist, then you will need to install one from each engine in order to use both MAP Sensors. **NOTE:** Use of p/n EA-5000 is optional. Leaving p/n: EA-5000 out of the system will simply cause the EIS to remain at a constant spark advance and not adjust spark timing for various manifold pressure readings, or altitude. This will reduce your fuel efficiency and the overall performance of the ignition system, but will not harm any engine components.
- c Locate an appropriate location to mount both MAP Sensors. Preferably, this location should be inside the cockpit or somewhere where the temperatures will not exceed 150°F. Keep in mind all of the considerations that were mentioned in Step 5. Review step 5.a for installation notes.
- d Mount both MAP Sensors using standard AN type hardware.
  - i Mounting holes are sized for #6 fasteners. Use AN machine screws and either locking nuts or lock washers with plain nuts for installation.
  - ii Connect a secondary ground to both MAP Sensors. A secondary ground wire should be connected to both MAP Sensors where indicated (observe that paint has been removed from the bottom side of the MAP Sensor cases showing the connection point).
- e Connect the manifold pressure line from the LEFT engine to the MAP Sensor that has been installed for the LEFT engine's EIS Kit.
  - i **WARNING:** Each MAP Sensor must be connected to the manifold pressure line from the engine the MAP Sensor's EIS is controlling. If the manifold pressure line is not from the correct engine, the EIS will not operate properly and could cause serious damage to the engine.
  - ii **CAUTION:** Be careful not to apply to much force to the MAP Sensor hose when connecting it to the aircraft's manifold pressure line. Improper forcing of the hose can cause internal damage to the MAP Sensor.
  - iii If a Manifold Pressure gauge is installed, you can "T" into the manifold pressure line that is feeding the Manifold Pressure gauge.
    - 1.) The hose coming from the MAP Sensor is MIL-H-5593 type hose commonly used in vacuum line installation (either Aeroquip 306 or Stratoflex 193). This size is -3 or 3/16"ID.
    - 2.) You may connect to your manifold pressure line with either standard fittings or other appropriate fittings for this application.
    - 3.) Verify that all connections and lines are tight and secure.
- f Connect the manifold pressure line from the RIGHT engine to the MAP Sensor that has been installed for the RIGHT engine's EIS Kit.
  - i **WARNING:** Each MAP Sensor must be connected to the manifold pressure line from the engine the MAP Sensor's EIS is controlling. If the manifold pressure line is not from the correct engine, the EIS will not operate properly and could cause serious damage to the engine.
  - ii **CAUTION:** Be careful not to apply to much force to the MAP Sensor hose when connecting it to the aircraft's manifold pressure line. Improper forcing of the hose can cause internal damage to the MAP Sensor.

- iii If a Manifold Pressure gauge is installed, you can “T” into the manifold pressure line that is feeding the Manifold Pressure gauge.
  - 1.) The hose coming from the MAP Sensor is MIL-H-5593 type hose commonly used in vacuum line installation (either Aeroquip 306 or Stratoflex 193). This size is -3 or 3/16”ID.
  - 2.) You may connect to your manifold pressure line with either standard fittings or other appropriate fittings for this application.
  - 3.) Verify that all connections and lines are tight and secure.
- iv If a Manifold Pressure gauge is not installed and you have created a new manifold pressure line, connect that new line directly to the hose coming from the MAP Sensor using standard fittings. The hose coming from the MAP Sensor is MIL-H-5593 type hose commonly used in vacuum line installation (either Aeroquip 306 or Stratoflex 193). This size is -3 or 3/16”ID.

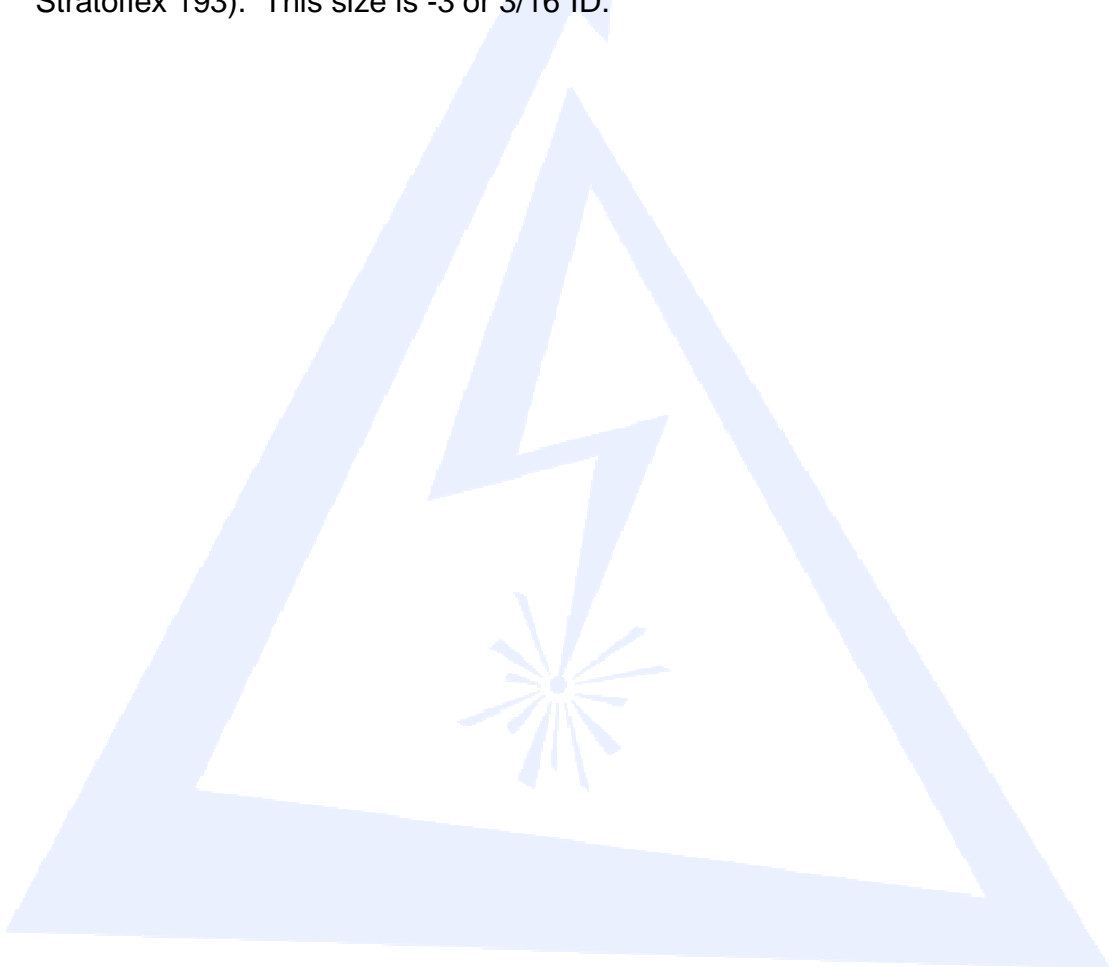

## 7. Installation of p/n: EA-4000 Spark Plug Harnesses:

- a You can now install the spark plugs that will be connected to the Electronic Ignition Systems. We recommend that you use new aircraft spark plugs. If you are re-using the old spark plugs, make sure that they are clean.
  - i **Optional:** Electroair has approved two wide gap aircraft spark plugs for use with our Electronic Ignition Systems. These spark plugs are manufactured with the wider air gap Electroair recommends be used with the Electronic Ignition Systems. These Electroair spark plugs are not included in the standard EIS Kit. These plugs are only approved to be used with Electroair's Electronic Ignition Systems. The Electroair part numbers and descriptions for these plugs are below:
    - 1.) **EAREM37HE Massive Electrode Spark Plug:** This plug is Electroair's version of the standard REM37BY spark plug. The EAREM37HE plug is manufactured with a 0.036" air gap. The EAREM37HE spark plug can be installed on the engines that are approved for the REM37BY spark plug, but can only be operated by an Electroair EIS. Please contact Electroair or one of our distributors for current pricing and availability of this spark plug.
    - 2.) **EARHM38SE Single Fine Wire Spark Plug:** This plug is Electroair's version of the standard RHM38S spark plug. The EARHM38SE is manufactured with a 0.036" air gap. The EARHM38SE spark plug can be installed on the engines that are approved for the RHM38S spark plug, but can only be operated by an Electroair EIS. Please contact Electroair or one of our distributors for current pricing and availability of this spark plug.
  - ii For all other aircraft spark plugs, Electroair recommends that you open the gap of the spark plugs to 0.030" - 0.036". We suggest using the REM37BY (or UREM37BY) spark plug because they are the easiest to gap. Check the engine application data to verify that these plugs can be used in your engine. **CAUTION:** Be careful when gapping all other plugs than the REM37BY (UREM37BY) plug, because the outer electrode can become over-stressed and break. If you have any problems with plug selection, please give us a call.
- b Each EIS Kit came with two spark plug wire bundles and an EA-4000 REM Hardware Kit. Each bundle will make two spark plug wires. **Note:** The EIS Kit comes with REM spark plug hardware. If you are using RHM spark plugs, please contact Electroair for RHM hardware replacements **CAUTION:** Since each assembly makes two spark plug wires, be careful when determining spark plug wire length.
  - i Route the spark plug wire from the coil pack to the correct cylinder (See Coil Pack label for wire orientation) to determine the spark plug wire length. Make sure to keep spark plug wire routings away from exhaust pipes. Wires routed parallel to each other require a minimum of ¼" of separation.
  - ii Cut the spark plug wire leaving enough length to go three inches beyond the spark plug.
  - iii Slide the aluminum nut, receptacle, washer, and gasket on the wire. Approximately one inch of wire should extend past the gasket. See Figure 7.1 for the correct component stack-up.
  - iv The wire supplied is a spiral core wire with a non-conductive center (Kevlar fibers). Insert the spark plug spring on the inside of the spiral core so that the spring 'tail' makes contact with the spiral core. You should feel the spring 'tail' as it hits the

spiral core during the insertion. **CAUTION:** do not install the spring tail directly in the center of the Kevlar fibers as it will not make contact with the spiral core. **OPTIONAL:** you may strip ~1/8" of the ignition wire insulation to expose the spiral core wire to make installing the spring easier.

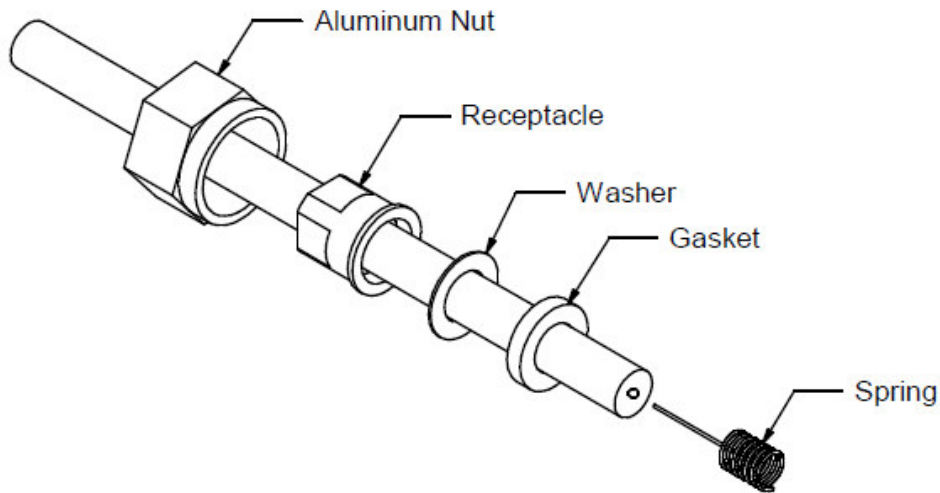

**Figure 7.1 Spark Plug Wire Hardware Assembly**

- v To finish the connection, install the spark plug end of the wire first. This prevents the spark plug wire from twisting as the spark plug nut is tightened. **CAUTION:** Do not over-tighten the spark plug nut as this may cause separation of the core of the wire. Tighten the spark plug nut to a torque value of 95 in-lb
- vi Attach the other end of the spark plug wires to the coil pack at their appropriate coil tower. **NOTE:** When you insert the 90° boot over each tower on the coil pack, you should hear an audible “SNAP” when the wire is properly installed onto each tower. If you do not hear this snap, remove the boot from the tower and repeat this step until you hear this “SNAP”.
- vii Coil towers are numbered on the coil pack: 1, 2, 3, and 4. Because of the nature of the system, coil towers 1 & 2 will fire simultaneously and then coil towers 3 & 4 will fire simultaneously.
- viii For all Lycoming engines, hook-up the spark plug wires according to the following chart:

Coil Pack	Tower 1	Tower 2	Tower 3	Tower 4
Cylinder #	1	2	3	4

- ix The coil towers should be oriented towards the same side of the engine as the cylinders – this should make spark plug wire hook-up easier



## **8. Connection of p/n: EA-6000T Twin Engine Wiring Harnesses:**

- a **Verify that the master switch is off and battery is disconnected.**
- b The electrical connections that will be made are as follows:
  - i. Harness to p/n: EA-1000, EIS Controller
  - ii. Harness to p/n: EA-5000, MAP Sensor
  - iii. Harness to p/n: EA-3000, EA-3000LH, EA-3000IC, or EA-3000LHIC MTH
  - iv. Harness to p/n: EA-2000, Coil Pack
  - v. Harness to Switched Power & Ground for EIS Controller
  - vi. Harness to Tachometer
- c Use the aircraft's existing wire runs as a guide for routing the EA-6000T Twin Engine Wiring Harnesses from the cabin to both wing mounted engines.

***CAUTION: Prior to any drilling, verify that there is clearance from any components on both sides of the firewall.***

- d **NOTES:** The main harness is assembled so it can be installed through tight clearances such as a hole in the fire wall. You will need to supply terminations for switches, circuit breakers, and the bus bar. A wiring diagram with pin-out information has been supplied at the end of this section for reference. **CAUTION:** Follow these wiring instructions very carefully to insure a correct hook-up of your EIS. Skipping ahead or taking short cuts increases the risk of an incorrect installation and either a poor performing EIS or the possibility of damaging equipment. Please call us if you have any questions.
- e **Harness to p/n: EA-1000, EIS Controller:**
  - i Connect the wiring harness assembly to the EIS Controller. This is done by inserting the 23 pin female connector into the male header on the Controller. The harness is properly installed when the clip on the 23 pin connector is securing the connector to the header. You will begin routing the various harness bundles and wires from here.
- f **Harness to p/n: EA-5000, MAP Sensor:**
  - i Route the harness with the WHITE three pin connector to the MAP Sensor from the Controller.
  - ii Connect this connector to the MAP Sensor; loop any extra wire and secure with cable ties.
    - 1.) Attached to the connector end of the harness is a loose white and black striped wire. Connect this wire to any ground source. This can be connected to the Secondary Ground connection on the MAP Sensor.
- g **Harness to p/n: EA-3000, EA-3000LH, EA-3000IC, or EA-3000LHIC MTH:**
  - i Route the harness with the square BLACK three pin connector to the EA-3000, EA-3000LH, EA-3000IC, or EA-3000LHIC MTH.
  - ii From the already installed MTH, there will be a wire harness terminated with a female square BLACK three pin connector. See Figure 8.1 below.



Figure 8.1: MTH and 3 Pin Female Connector

- iii Connect the connector from the routed harness to the connector on the MTH. Verify that the connection is secure.
- iv Loop any excess wire and secure with cable ties.
- h **Harness to p/n: EA-2000, Coil Pack:**
  - i Route the harness with the round BLACK connector to the Coil Pack. This harness is terminated with a round plug type connector. See Figure 8.2 below for how the harness should look.

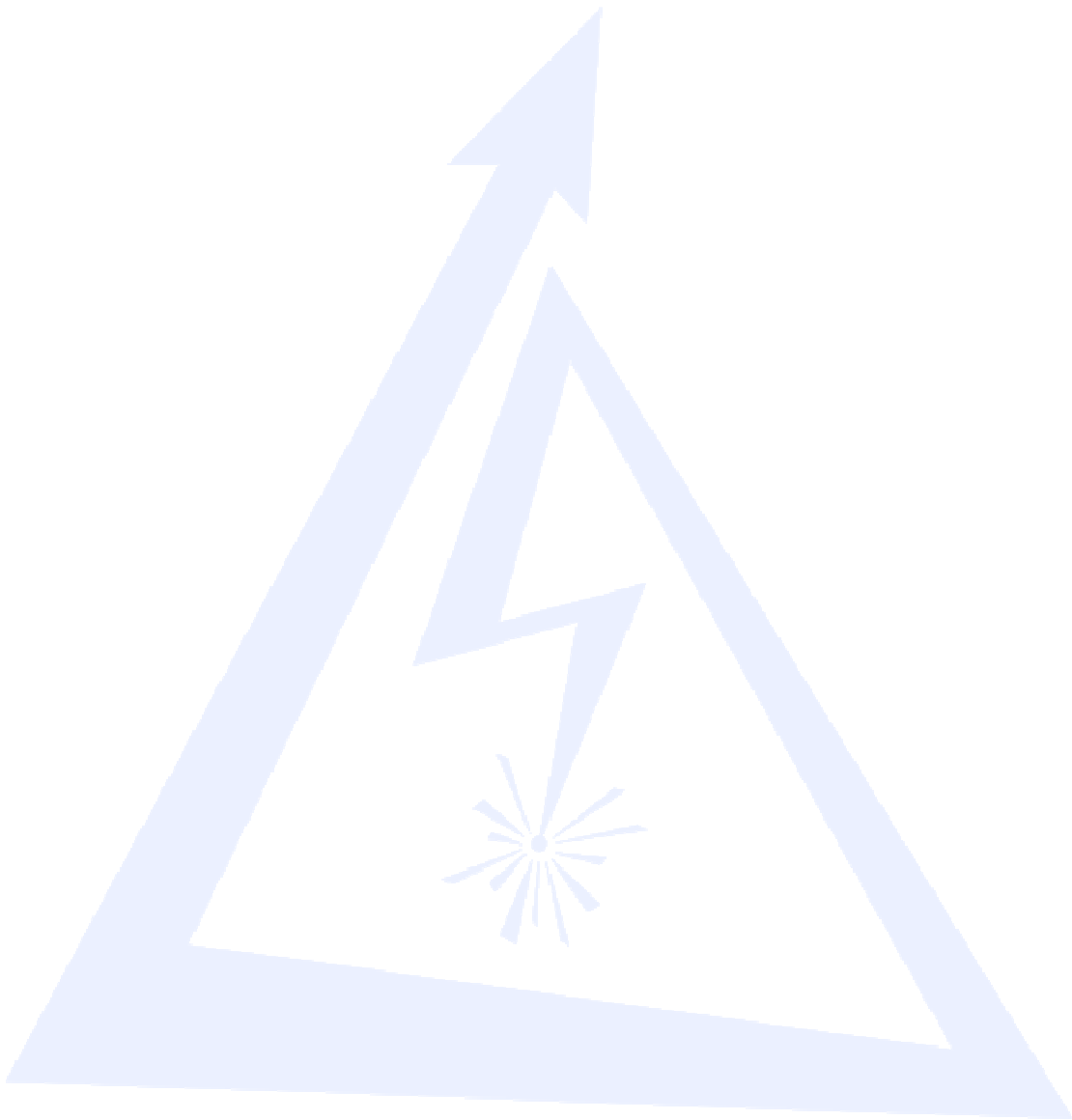

Figure 8.2: Coil Pack Harness Plug

- ii Connect the connector from the harness to the mating connector on the Coil Pack.

- iii Route the unterminated end of the Red wire from the harness through a 10 amp breaker (fuses may be used as an alternative to the breaker) to the Essential Bus Bar. Trim and terminate as required.
  - iv Loop any excess wire and cable tie or clamp the loop to a convenient location that does not interfere with any components (a location on the inside of the firewall is suggested).
- i **Harness to Switched Power & Ground for EIS Controller:**
- i Go to the harness connector that is installed on the Controller.
  - ii Obtain the RED wire that is coming out of this connector.
  - iii Route the loose end of this RED wire to the existing ignition switch that was used to operate the magneto that is being replaced by this EIS, reference step 2.d for switch clarification. **CAUTION:** Make sure that the ignition switch and EIS are used to control the same engine.
    - 1.) Remove all existing wires that are connected to the airframe from this ignition switch.
    - 2.) Determine the orientation of the switch when the switch is "OPEN" and when the switch is "CLOSED". When the switch is "CLOSED" the EIS will be "ON" and when the switch is "OPEN" the EIS will be "OFF".
    - 3.) If needed, rotate the EIS switch so that the EIS switch in its "OPEN" position is in the same orientation as the existing MAG switches in their "OFF" position. **NOTE:** When this step is complete, all of the ignition switches should be in the same position when they are "ON" and when they are "OFF".
    - 4.) Trim and Terminate the RED wire from the EIS harness to this ignition switch.
    - 5.) Connect the other end of the ignition switch to a 2 amp breaker or fuse.
    - 6.) Connect the 2 amp breaker or fuse to the essential bus bar.
    - 7.) The power for the EIS Controller has now been installed to be turned ON and OFF by the existing ignition switch.
  - iv Go to the harness connector that is installed on the Controller.
  - v Obtain the 16 gauge Black wire, labeled "ELECTROAIR GROUND", that is coming out of this connector.
  - vi Trim & Terminate the Black wire to a competent aircraft ground.
- j **Harness to Tachometer:**
- i Go to the harness connector that is installed on the Controller.
  - ii Obtain the 22 gauge BLACK wire, labeled "ELECTROAIR TACHOMETER", that is coming out of this connector.
  - iii The Tachometer output signal is a 12V or 24V (dependent on aircraft system voltage) square wave with two pulses per revolution. **CAUTION:** Verify that the Tachometer or engine monitor system that you are using can receive the above signal before connecting and operating. Incorrect signal types can cause incorrect readings or potentially damage monitoring systems.
  - iv Route this BLACK wire to Tachometer or monitor system and install the lead as specified by the equipment manufacturer.
    - 1.) Loop any excess wire and cable tie or clamp the loop to a convenient location that does not interfere with any components

- v If you do not intend to use this output, then this bundle should be looped and tied to an appropriate place. Alternatively, this wire can be trimmed out of the harness connector if this option will never be used.



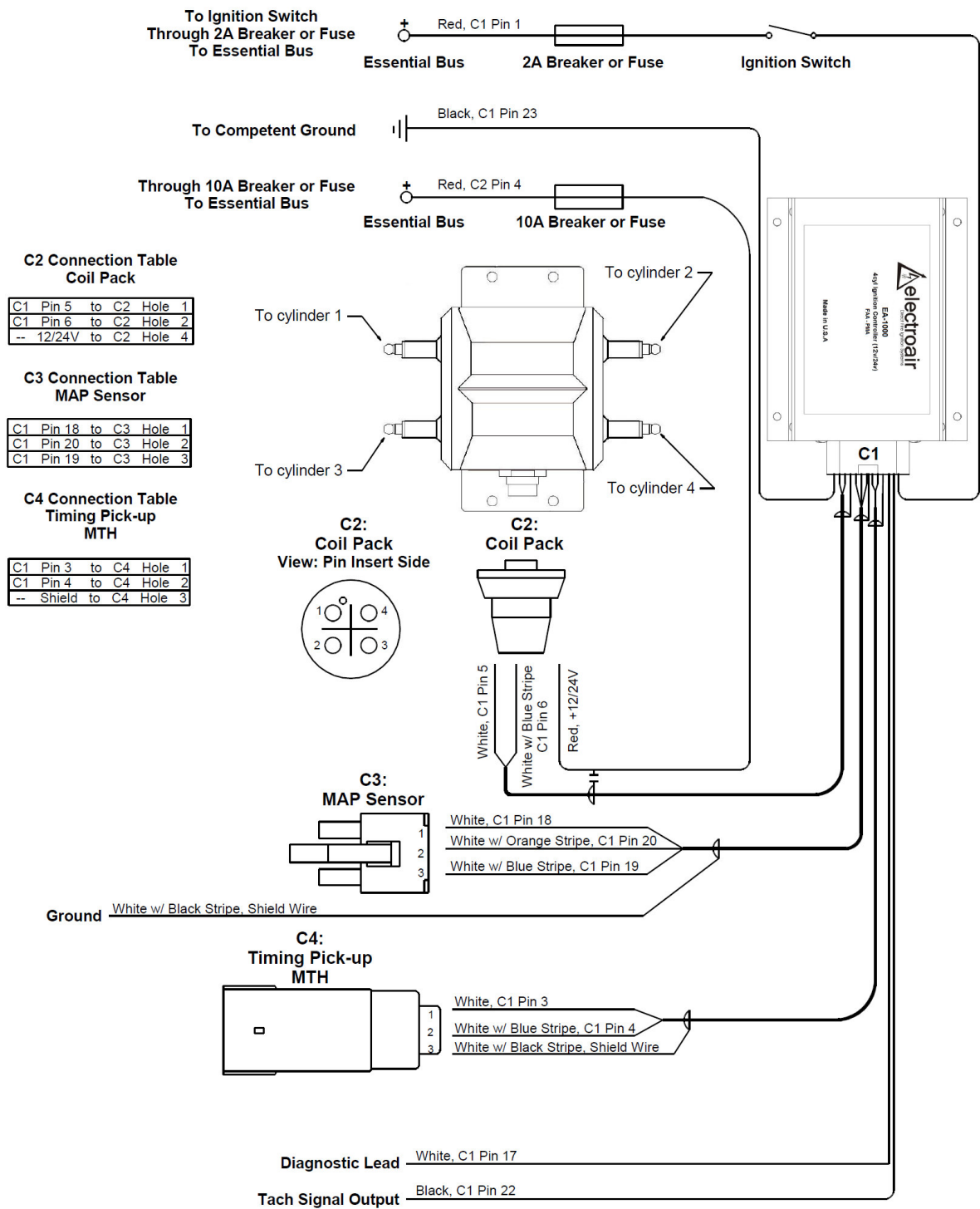

## Wiring Diagram for EIS-41000T, EIS-41000TIC, EIS-41000TLH, & EIS-41000TLHC

## 9. Instrument Panel EIS Labeling:

- a Each twin engine EIS Kit contains an Instrument Panel Label Kit which contains different EIS labels for the instrument panel. These labels include the following:
  - i “EIS LEFT” Label: This label is roughly 5/8” x 3/8” and is intended to be used on the LEFT ignition switch, if the EIS replaced the LEFT magneto on that switch’s engine.
  - ii “EIS RIGHT” Label: This label is roughly 5/8” x 3/8” and is intended to be used on the RIGHT ignition switch, if the EIS replaced the RIGHT magneto on that switch’s engine.
  - iii “LEFT ENG. EIS” Labels: These labels are intended to identify the 2 amp and 10 amp breakers that have been installed on the instrument panel for the LEFT engine’s EIS.
  - iv “RIGHT ENG. EIS” Labels: These labels are intended to identify the 2 amp and 10 amp breakers that have been installed on the instrument panel for the RIGHT engine’s EIS.
- b Labeling the LEFT engine’s EIS ignition switch:
  - i Obtain the Instrument Panel Label Kit from the EIS Kit.
  - ii Locate the two ignition switches for the LEFT engine.
  - iii Determine which ignition switch is the EIS ignition switch.
  - iv Obtain one cleaning wipe from the label kit.
  - v Use the cleaning wipe to clean the residue off of the EIS ignition switch.
  - vi Allow any cleaning solution to dry before placing label on switch.
  - vii Obtain the EIS label that corresponds with the existing labeling on the EIS ignition switch. **EXAMPLE:** If the EIS switch is labeled “RIGHT MAG”, obtain the “EIS RIGHT” label. If the EIS switch is labeled “LEFT MAG”, obtain the “EIS LEFT” label.
  - viii Before permanently placing the EIS label on the switch, verify that the EIS label will properly cover the existing “MAG” labeling on switch. If the EIS label extends off of the switch, trim label so it is flush with the sides of the switch.
  - ix Remove the adhesive cover from the back of the EIS label and place the EIS label over the “MAG” labeling on the switch. Apply pressure to the label to ensure proper adhesion of the label to the switch.
- c Labeling the RIGHT engine’s EIS ignition switch:
  - i Obtain the Instrument Panel Label Kit from the EIS Kit.
  - ii Locate the two ignition switches for the RIGHT engine.
  - iii Determine which ignition switch is the EIS ignition switch.
  - iv Obtain one cleaning wipe from the label kit.
  - v Use the cleaning wipe to clean the residue off of the EIS ignition switch.
  - vi Allow any cleaning solution to dry before placing label on switch.
  - vii Obtain the EIS label that corresponds with the existing labeling on the EIS ignition switch. **EXAMPLE:** If the EIS switch is labeled “RIGHT MAG”, obtain the “EIS RIGHT” label. If the EIS switch is labeled “LEFT MAG”, obtain the “EIS LEFT” label.
  - viii Before permanently placing the EIS label on the switch, verify that the EIS label will properly cover the existing “MAG” labeling on switch. If the EIS label extends off of the switch, trim label so it is flush with the sides of the switch.
  - ix Remove the adhesive cover from the back of the EIS label and place the EIS label over the “MAG” labeling on the switch. Apply pressure to the label to ensure proper adhesion of the label to the switch.

- d Labeling the LEFT engine's EIS circuit breakers:
  - i Obtain the Instrument Panel Label Kit from the EIS Kit.
  - ii Locate the two circuit breakers for the LEFT engine's EIS. These breakers should include one 2 amp breaker and one 10 amp breaker.
  - iii Obtain one cleaning wipe from the label kit.
  - iv Use the cleaning wipe to clean the residue off of the panel area just under each breaker.
  - v Allow any cleaning solution to dry before placing labels on the panel.
  - vi Obtain two "LEFT ENG. EIS" labels from the label kit. NOTE: There are two types of circuit breaker labels in each kit, a long and thin label type and a short and wide label type. Use the type of label that works best for your installation.
  - vii Before permanently placing the EIS labels on the panel, verify that there is proper room in the desired panel locations to fit the EIS labels.
  - viii Remove the adhesive cover from the back of each EIS label and place the EIS labels under both breakers. Apply pressure to the label to ensure proper adhesion of the label to the switch.
- e Labeling the RIGHT engine's EIS circuit breakers:
  - i Obtain the Instrument Panel Label Kit from the EIS Kit.
  - ii Locate the two circuit breakers for the RIGHT engine's EIS. These breakers should include one 2 amp breaker and one 10 amp breaker.
  - iii Obtain one cleaning wipe from the label kit.
  - iv Use the cleaning wipe to clean the residue off of the panel area just under each breaker.
  - v Allow any cleaning solution to dry before placing labels on the panel.
  - vi Obtain two "RIGHT ENG. EIS" labels from the label kit. NOTE: There are two types of circuit breaker labels in each kit, a long and thin label type and a short and wide label type. Use the type of label that works best for your installation.
  - vii Before permanently placing the EIS labels on the panel, verify that there is proper room in the desired panel locations to fit the EIS labels.
  - viii Remove the adhesive cover from the back of each EIS label and place the EIS labels under both breakers. Apply pressure to the label to ensure proper adhesion of the label to the switch.
- f **All switches and breakers/fuses that are connected to an EIS MUST be labeled with either the labels included in each EIS kit or an Electroair approved alternative.**

## **10. Final Installation Steps:**

- a Calibration and Timing settings: Your unit has been pre-set at the factory for a base timing of 25 deg BTDC (base timing is always placarded timing for the engine). Please contact us if you feel that your unit is not performing optimally, or if that base timing needs to be adjusted.
- b Re-attach and reinstall any connections or components that were removed or loosened during this installation.
- c Secure all new wires, harness, connections and lines to prevent failures due to vibration.
- d Connect battery connections and close any open circuit breakers.
- e Recover all tools that may have been used (you don't want any tools 'floating' around inside the airplane).
- f Using the Approved Flight Manual Supplement for the EIS, perform a test run-up before flying.

## **11. Installation Options Available from Electroair:**

- a MTH Holders: You may use Slick p/n: K-3328
- b P/N: EAREM37HE. Electroair's Massive Electrode Spark Plug. This plug is Electroair's version of the standard REM37BY spark plug manufactured with a 0.036" air gap and has been approved for use with only Electroair's electronic ignition systems. These plugs come with the increased air gap Electroair recommends be used with our systems and eliminates the time and headache of re-gapping standard aircraft spark plugs. These Electroair spark plugs are not included in the standard EIS Kit. Please contact Electroair or one of our distributors for current pricing and availability of this spark plug.
- c P/N: EARHM38SE. Electroair's Single Fine Wire Spark Plug. This plug is Electroair's version of the standard RHM38S spark plug manufactured with a 0.036" air gap and has been approved for use with only Electroair's electronic ignition systems. These plugs come with the increased air gap Electroair recommends be used with our systems and eliminates the time and headache of re-gapping standard aircraft spark plugs. These Electroair spark plugs are not included in the standard EIS Kit. Please contact Electroair or one of our distributors for current pricing and availability of this spark plug.
- d Other options will be announced when available.



**EIS-41000 Installation Manual  
Record of Revisions**

Revision Number	Date of Revision	Description of Revision	Date of Approval
1	N/A	DRAFT	UNAPPROVED DRAFT
2	N/A	DRAFT	UNAPPROVED DRAFT
3	6/8/2011	Original	7/5/2011
4	8/26/2011	Revision based on DER Report Number ELA-1101	10/7/2011
5	3/14/2012	Included installation instructions for installing the EIS-41000IC and EA-3000IC. Reworded P/N EA-6000 installation instructions for clarity, to address the use of fuses, and to address the use of non-rotary style ignition switches. Also, added this record of revisions section to the installation manual.	4/6/2012
6	7/23/2012	Included optional use of Electroair Spark Plugs, part numbers EAREM37HE and EARHM38SE, to sections 2, 3.7, & 3.10 of this manual.	7/25/2012
7	11/8/2012	Included installation instructions for Twin Engine Aircraft EIS Kits P/N's: EIS-41000T, EIS-41000TIC, EIS-41000TLH, EIS-41000TLHIC.	